

# **TURBOVAC**

QUALITY VACUUM SYSTEMS

## User Manual

### Vacuum Packaging Machines



S20, S30,  
S40, S50, S60

M10, M20, M30

M40, M50, M60

M70, M80

L10, L30, L40

L60

http: //www.turbovac.nl  
e-mail: info@turbovac.nl  
tel: +31736271201

**SERIAL NUMBER**

art.nr. 9606.042EN

# CAPTURE QUALITY

## 1.0 Safety Regulations and Warnings

### General

The manufacturer of this equipment accepts no liability whatsoever for damage or injury caused by failing to adhere to the directions and instructions in this manual, or through carelessness during the installation, use, maintenance and repair of the machine identified on the front of this document, or any of its accompanying options or components.

The owner of the machine is fully responsible at all times for the adherence to the locally applicable safety regulations and guidelines. Obey all safety instructions and guidelines as provided in this manual.

### User Manual

- Every user of the machine should be familiar with the contents of this manual and follow its instructions carefully. Management must train the appropriate personnel on the basis of this manual and make sure that all directions and indications are adhered to
- Never change the order of the actions to be taken
- Always keep the manual in the proximity of the machine

### Pictograms and Instructions on the Machine

- The labels with pictograms, warnings and instructions that are attached to the machine are part of the safety measures taken. These labels should not be damaged or removed and should remain present and legible throughout the life of the machine
- Immediately replace or repair any labels that are damaged or have become illegible

### Intended Use of the Machine <sup>1</sup>

The machine is designed for commercial use only for vacuum packaging of food or other products for 8 hours a day, 5 days a week. Any other or extended use is not in accordance with this purpose and the manufacturer accepts no liability for any resulting damage or injury. Only use this machine while in perfect technical condition in accordance with the above mentioned purpose.

### Technical Specifications

The specifications outlined in this manual may not be altered.

### Modifications

Modifications of the machine or its components is not permitted.

### Safety Measures

The machine is equipped with the following standard safety devices:

- Short-circuit and overload safety
- Pump fan guards

All safety devices must be correctly installed and may only be removed to accommodate maintenance and repair activities by trained and authorized service personnel. The machine may never be operated while safety measures are incomplete, deactivated or absent. The safety devices may never be by-passed.

<sup>1</sup> The “use in accordance with purpose”, as established in EN 292-1, is the use for which the technical product is suitable according to the statement by the manufacturer, including his directions in the sales brochure. When in doubt, it is the use that manifests itself as the most common, based on the construction, model and function of the product. Use in accordance with the purpose also means adhering to the instructions in the user manual.

## 2.0 Table of Contents

1.0	Safety Regulations and Warnings	2
2.0	Table of Contents	3
3.0.	Welcome	5
3.1	Service from your Dealer	5
3.2	YouTube Turbovac Channel - Instruction and Service Videos	5
3.3	General Precaution	5
4.0	Installation of Machine	6
4.1	Gas Connection for MAP Applications	6
4.2	Compressed Air Connection for Additional Sealing Pressure	6
5.0	Overview of Main Machine Components	7
6.0	Digital Control with LCD Display	8
6.1	One-Program Control System	8
6.2	<b>Operating the Machine with One-Program Control System</b>	9
6.3	Ten-Program Control System	10
6.3.1	Time-Based Operation	10
6.3.1.1	Option Sensor and option Soft-Air retrofit	10
6.3.2	Sensor-Based Operation	10
6.3.2.1	Option Soft-Air retrofit	10
6.4	<b>Operating the Machine with Ten-Program Control System</b>	11
7.0	<b>Programming the Machine</b>	13
7.1	One-Program Control System	13
7.1.1	Programmable Functions	13
7.1.2	Programming	13
7.1.3	Reviewing Function Values for P1	13
7.1.4	Adjusting the Vacuum Time for P1	13
7.1.5	Adjusting the Sealing Time for P1	13
7.1.6	Turning Off Machine	14
7.2	Ten-Program Control System	14
7.2.1	Programmable Functions	14
7.2.2	Reviewing Function Values for P1-P9	14
7.2.3	Programming adjusting Function Values for P1-P9	15
7.2.4	Turning Program Functions ON/OFF	15
7.2.5	Adjusting ON/OFF Functions	15
7.2.6	Turning Off Machine	15
8.0	Symbols in Display	16
9.0	Standard Vacuum Pump Settings: runs continuously or turns off end of cycle	18
9.1	One-Program Control System (stop cycle and aerate, or next step)	18
9.2	Ten-Program Control System (stop cycle and aerate, or next step)	18
10.0	Explanation terminology used	19
10.1	Sensor-Based Control	19
10.2	Time-Based Control	19
10.3	P H <sub>2</sub> O Program for Liquid Products	19
10.4	Vacuum Plus	19
10.5	MAP Gassing	20
10.6	Sealing	20
10.7	Extra Sealing Pressure	22
10.8	Soft-Air	22
10.9	Multi-Cycle	22
10.10	Cool-Down/Oil Dehumidification	22

11.0	Maintenance	22
11.1	General	22
11.2	Vacuum Pump	22
11.3	Pump Oil, add or replace	23
11.4.0	Seal Beams and Counter Beams	24
11.4.1	Single-Seal Beam	24
11.4.2	Aluminum/Stainless Steel Seal Beam	24
11.4.3	Aluminum T-Shaped Seal Beam	26
11.4.4	Applying Teflon Tape to Seal Beam	26
11.5	Replacing Silicone Rubber Seal of Counter Beam	27
11.6	Rubber Seal of Vacuum Chamber Cover	27
11.7	Struts, Dampers and Springs	27
11.8	Vacuum Hoses and Tubes	27
12.0	Malfunctions and Notifications	28
12.1	Service and Technical Support	28
12.2	YouTube Turbovac Channel - Instruction and Service Videos	28
12.3	Trouble Shooting Check List	28
13.0	Recommended Spare Parts	29
14.0	Utilities	30
14.1	General data	30
15.0	Commonly-Used Symbols	30
16.0	CE Declaration of Conformity	31

### 3.0 Welcome

Thank you very much for your purchase of a Turbovac vacuum packaging machine. In order to guarantee the reliability, longevity and robustness of your equipment, we only used materials of the highest quality in the fabrication of your machine. During its design, it was our goal to make it easy to use and simple to maintain.

Based on your purchase of this machine, we assume that you are familiar with the fundamentals of vacuum packaging. For additional information and guidance about vacuum packaging applications, we recommend that you contact your dealer.

To find out the location of your nearest dealer, please contact us at:  
+31 73 627 12 73 or 77  
or via e-mail info@turbovac.nl

### 3.1 Service from your Dealer

For technical support, please contact your dealer.

You may also contact us, so that we can assist you in locating your nearest dealer:  
+31 73 627 12 73 or 77

Please have the following information available:

- **Machine type**
- **Serial number**

You can locate the serial number on the front page of this manual. In addition, you can find it on the identification plate on the right-hand side or back-side of your machine.

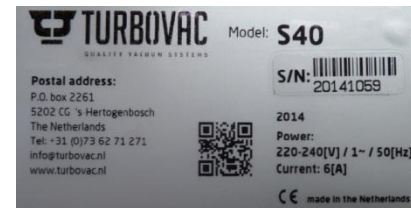

### 3.2 YouTube Turbovac Channel - Instruction and Service Videos

Instructional videos are placed on YouTube for the operation and service of your machine. You may locate these videos on the YouTube website under "Turbovac Channel".

### 3.3 General Precaution

The vacuum machines must be connected to a grounded, metal, permanent wiring system or an equipment-grounding conductor must be run with the circuit conductors and connected to the equipment-grounding terminal or lead on the product.

For the table top models: "to provide continued protection against risk of electric shock connect to properly grounded outlets only".

For all models: "to reduce risk of electric shock and injury to persons, disconnect from power supply before servicing"

## 4.0 Installation of Machine

### General

- Level the machine on a flat firm surface
- Position the machine in such a manner that the pump is unobstructed and properly ventilated
- Engage the locks on the wheels, if so equipped
- Check the oil level in the pump; add oil if necessary
  - Never operate the machine when the oil level is low



Table-Top Model

Oil sight glass

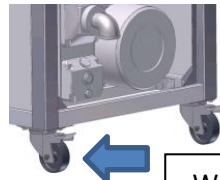

Mobile and Double-Chamber Models

Wheel locks



Oil sight glass

### Electrical Connection 3-phase vacuum pump

If the machine is incorrectly hooked up to a three-phase electrical connection, the pump will make excessive noise. If this happens, take the following steps:

- Turn the pump off immediately
- Switch the phase wires
- Make sure that the rotation direction of the pump matches the arrow on the motor housing



### Turning on Machine

- If so equipped, like some mobile and double-chamber models, turn on the main power switch on the back of the machine
- Push the on/off button on the control panel of the machine



### 4.1 Gas Connection for MAP Applications (Modified Atmosphere Packaging)

- Connect the gas supply line to the inlet on the back of the machine
- Maximum pressure: 1 bar
- Anchor the gas cylinders securely to prevent them from falling over
- Make sure that the work area is well-ventilated
- To assure that you use the appropriate gas for your application, consult your dealer or gas supplier
- Assure a good connection and use high-quality materials



### 4.2 Compressed Air Connection for Additional Sealing Pressure

- Additional sealing pressure is usually recommended for MAP applications only
- The M40-M80 and the L10-L60 models with the option Gas/MAP are standard equipped with a compressed air inlet
- Extra sealing pressure is not necessary and not available for the Table-Top, M10, M20, M30
- Consult your dealer for installation details
- Maximum pressure: 1 bar
- Assure a good connection and use high-quality mater





## 5.0 Overview of Main Machine Components



On the back side of the machine:

- J Main switch
- K MAP gas connection
- L Compressed air connection



Position	Description	Page	Position	Description	Page
A	Control panel	8-18	H	Silicone sealing gasket	27
B	Seal beam (located in the cover on the double-chamber machines)	24-26	I	Identification plate	5, 28
C	Counter beam	27	J	Main switch	
D	MAP gassing pipes	20	K	MAP gas connection	20
E	Fitting plates (optional)		L	Compressed air connection (extra sealing pressure option)	21
F	Exhaust (located in the cover on double-chamber and some mobile models)		M	Wheel with lock	
G	Cover lock (not for double-chamber machines)				

## 6.0 Digital Control with LCD Display

Some Turbovac vacuum machines have a control system with just one Program (P1). Other machines have an optional expanded control system, which can accommodate up to 9 custom programs (P1-9).

### 6.1 One-Program Control System

Turbovac machines with the One-Program control system can be programmed for the following 2 functions:

1. Vacuum time (seconds)
2. Sealing time (seconds)

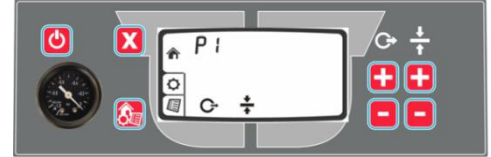























- The values for vacuum and sealing times are selected by the user and saved in program P1
- During operation, the LCD display will show symbols to indicate the active function and the progress of the packing cycle
- The actual vacuum pressure is indicated by the analog vacuum gauge





#### Plug & Play

- When turning on the machine for the first time:
  - running time of the vacuum pump is pre-set at 30-40 seconds and the sealing time at 2 seconds. Vacuum is indicated on the analog vacuum gauge.
- When turning on the machine after that, program P1 will contain the most-recently used settings
- The vacuum and sealing times are easily adjusted to match the needs for the application



## 6.2 Operating the Machine with One-Program Control System

	<p><b>On: Turns the machine on</b></p> <ul style="list-style-type: none"> <li>○ The machine will start up in the most-recently used program</li> <li>○ The pump of a machine with a transparent cover will start when the cover is closed</li> </ul> <p><b>Off: Turns the machine off</b></p> <ul style="list-style-type: none"> <li>○ When pressing the  button once, the  symbol will start blinking and the pump will stop after about 4 seconds</li> <li>○ When pressing the  button a second time, the pump will stop immediately</li> <li>○ Closing the cover will initiate the cool-down phase; the machine will complete a number of vacuum cycles before turning off automatically</li> </ul>
	<p><b>Stop-function</b></p> <ul style="list-style-type: none"> <li>○ Stops the machine at any point in the packing cycle and aerates the chamber</li> </ul> <p><b>Reset-function</b></p> <ul style="list-style-type: none"> <li>○ While programming, resets the program value to its original setting</li> </ul> <p>Press the menu button  to return to the Home menu</p>
 Packing of sauce/soup	<p><b>Stops the current function and initiates the next step in the cycle</b></p> <ul style="list-style-type: none"> <li>○ By pressing the  of the sealing button , the vacuum function stops and the program jumps to the sealing function</li> <li>○ While packing sauce or soup, the package may be sealed as soon as product boiling is detected</li> </ul>
	<p><b>Entering the desired vacuum time</b> </p> <ul style="list-style-type: none"> <li>○ By pressing the + or – of the vacuum button , the vacuum time can be increased or decreased</li> </ul> <p><b>The selected value is confirmed and saved by pressing the menu button</b> </p> <ul style="list-style-type: none"> <li>○ Press the  button to reset the original value</li> </ul>
	<p><b>Entering the desired sealing time</b> </p> <ul style="list-style-type: none"> <li>○ By pressing the + or – of the sealing button , the sealing time can be increased or decreased</li> </ul> <p><b>The selected value is confirmed and saved by pushing the menu button</b> </p> <ul style="list-style-type: none"> <li>○ Press the  button to reset the original value</li> </ul>
	<p><b>Menu Button</b></p> <ul style="list-style-type: none"> <li>○ Confirms and saves the entered values for vacuum and sealing times</li> <li>○ Returns to the Home menu</li> </ul>
	<p><b>When turning off the machine with the  button, the  symbol will start blinking</b></p> <ul style="list-style-type: none"> <li>○ The pump will stop after about 4 seconds</li> <li>○ Press the  button a second time and the pump will stop immediately</li> <li>○ Close the lid; the machine initiates the cool-down phase and perform a number of vacuum cycles before turning off automatically</li> <li>○ These additional cycles allow any moisture in the oil of the pump to evaporate. This increases the longevity of the machine and minimizes the need for oil changes and pump maintenance</li> </ul> 

	<p><b>Service Symbol</b></p> <ul style="list-style-type: none"> <li>○ After a number of operating hours or packing cycles, the service symbol will briefly appear on the display when the machine is turned on. In addition, the display indicates how many hours or cycles remain before an oil change is required</li> <li>○ Except for regularly changing the oil in the pump (important!), the machine requires little other routine maintenance</li> <li>○ To reset the service interval counters after the oil change: Start machine  and while the display shows the hours or cycles, press and hold the  button</li> </ul>	
---	--	---

## 6.3 Ten-Program Control System

In addition to vacuum and sealing times, Turbovac machines with a Ten-Program control system may be programmed for several additional functions. Each of the 9 customizable programs is either

1. time-controlled
2. sensor-controlled

### 6.3.1 Time-Based Operation (vacuum gauge: mbar)

- The values for vacuum and sealing time, as well as the values for several optional functions, are selected by the customer and saved in any of 9 customizable programs P1-9
- When operating a packaging machine with a time-based program, the actual vacuum pressure is indicated by the analog vacuum gauge. The number of seconds of vacuum time remaining is shown on the LCD display

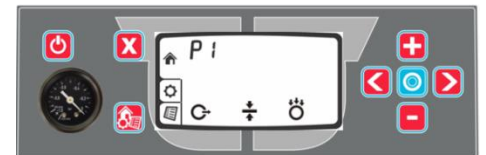

#### Plug & Play

- When turning on a time-based machine for the first time, it will start up in the PA program **AUTOMATIC**. This is a pre-set factory program with 30-40 seconds vacuum time and 2 seconds of sealing time
- When turning on the machine after that, it will start up in the most-recently used program

#### 6.3.1.1 Optional installation of a Sensor or Soft-Air

- A machine with a time-based control program can be upgraded to sensor-based operation at a later date by installing the optional sensor kit
- The Soft-Air feature can also be installed at a later date by ordering the optional soft-air kit

### 6.3.2 Sensor-Based Operation (digital display: mbar)

- When operating a packaging machine with a sensor-based program, the actual vacuum pressure is digitally shown on the LCD display in mbar (standard setting) or in % vacuum















#### Plug & Play











- When turning on a sensor-based machine for the first time, it will start up in the PA program **AUTOMATIC**. This is a pre-set factory program with 5 mbar of vacuum and 2 seconds of sealing time
- When turning on the machine after that, it will start up in the most-recently used program

#### 6.3.2.1 Optional installation of Soft-Air

- The Soft-Air feature can also be installed at a later date by ordering the optional soft-air kit

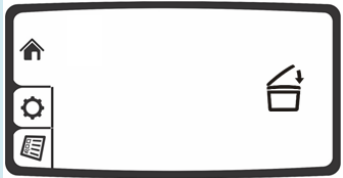
## 6.4 Operating the Machine with Ten-Program Control System

	<p><b>On: Turns the machine on</b></p> <ul style="list-style-type: none"> <li>○ The machine will start up in the most-recently used program</li> <li>○ The pump of a machine with a transparent cover will start when the cover is closed</li> </ul> <p><b>Off: Turns the machine off</b></p> <ul style="list-style-type: none"> <li>○ When pressing the  button <b>once</b>, the  symbol will start blinking and the pump will stop after about 4 seconds</li> <li>○ When pressing the  button a <b>second time</b>, the pump will stop immediately</li> <li>○ Closing the cover will initiate the cool-down phase (see page 21) <ul style="list-style-type: none"> <li>○ the machine will complete a number of vacuum cycles before turning off automatically</li> </ul> </li> </ul>
	<ol style="list-style-type: none"> <li><b>1. Stop-function</b> <ul style="list-style-type: none"> <li>○ Stops the machine at any point in the cycle and aerates the chamber</li> </ul> </li> <li><b>2. Reset-function</b> <ul style="list-style-type: none"> <li>○ While programming, resets the program value to its original setting</li> <li>○ Press the menu button  to return to the Home menu</li> </ul> </li> <li><b>3. Back function</b> <ul style="list-style-type: none"> <li>○ While reviewing programmed values, returns to the previous selection</li> </ul> </li> </ol>
 Packing of sauce/soup	<p><b>Stops the active function and initiates the next step in the cycle</b></p> <ul style="list-style-type: none"> <li>○ While the machine is running, exits the active function and jumps to the next step in the cycle</li> <li>○ While packing sauce or soup, the package may be sealed as soon as product boiling is detected</li> </ul>
	<p><b>Menu Button</b></p> <ol style="list-style-type: none"> <li><b>1. Toggles</b> between Home menu  and Settings menu </li> <li><b>2. Save Function:</b> During programming, confirms and saves the entered program values and returns to the Home menu</li> <li><b>3. Return Function:</b> Returns to the Home menu</li> </ol>
	<p><b>Review program values</b></p> <ol style="list-style-type: none"> <li><b>1. Cycles</b> through programs P1 to P9, as well as PA and P H2O</li> <li><b>2. Displays</b> the programmed value for each function; the function being reviewed will be blinking</li> <li>Displays the value for the next function</li> <li><b>Returns</b> to the Home menu</li> </ol>
	<p><b>Adjust program values and turn functions ON/OFF</b></p> <ol style="list-style-type: none"> <li><b>Forward or back;</b> adjusted values are saved right away</li> <li><b>Increases or decreases</b> function values</li> <li>Turns functions ON/OFF; specific functions, like soft-air, clean cut seal, etc., are turned either on or off</li> <li>If the function is turned on, the value may be adjusted by pressing the  and  buttons</li> <li><b>Resets</b> the original value</li> <li><b>Saves</b> changes and returns to the Home menu</li> </ol>

	<p><b>Multi-Functional button: Performs various functions, depending on the active menu</b></p> <p><b>Home menu:</b></p> <ul style="list-style-type: none"> <li>No effect while in the PA program</li> <li>For programs P1-9, displays the entered values</li> </ul> <p><b>Settings menu:</b></p> <ul style="list-style-type: none"> <li>For specific functions, like soft-air, clean cut seal etc., the  button is used to turn the function ON/OFF</li> </ul>
<p><b>P1 – P9</b></p> <p><b>PA</b> AUTOMATIC</p> <p><b>P H<sub>2</sub>O</b></p>	<p><b>Programs 1 through 9</b></p> <ul style="list-style-type: none"> <li>Each program may be customized by turning certain functions on or off and by adjusting the function values</li> </ul> <p><b>PA - Automatic</b></p> <ul style="list-style-type: none"> <li>Program with factory settings for vacuum and sealing functions, which is activated when turning on the machine for the first time</li> </ul> <p><b>P H<sub>2</sub>O – Program</b></p> <ul style="list-style-type: none"> <li>To be used when packing liquids or semi-liquids, like sauces and soups (see page 19)</li> <li>Program jumps to the sealing function as soon as product boiling is detected; this prevents product loss through spillage and evaporation</li> </ul>
	<p><b>When turning off the machine with the  button, the  symbol will start blinking on the LCD display</b></p> <ul style="list-style-type: none"> <li>The pump will stop after about 4 seconds</li> <li>Press the  button for a second time and the pump will stop immediately</li> <li>Close the lid; the machine will initiate the cool-down phase and perform a number of vacuum cycles before turning off automatically</li> <li>These additional cycles allow any moisture in the oil of the pump to evaporate. This increases the longevity of the machine and minimizes the need for oil changes and pump maintenance</li> </ul> 
	<p><b>Service Symbol</b></p> <ul style="list-style-type: none"> <li>After reaching a certain number of operating hours or packing cycles, the service symbol will briefly appear on the display when turning on the machine. In addition, the display indicates how many hours or cycles remain before an oil change is required.</li> <li>Except for regularly changing the oil in the pump, the machine requires little other routine maintenance</li> <li>After reaching the service limit, the display will indicate the negative number of exceeded operating hours or cycles</li> <li>To reset the service interval counters after the oil change: Start machine  and while the display shows the hours or cycles, press and hold the  button for</li> </ul> 

## 7.0 Programming the Machine

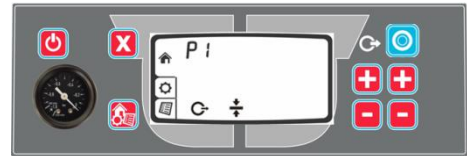

### 7.1 One-Program Control System

- The One-Program control system is standard on the S20, S30, S40, S50, M10, M30 (with 21m<sup>3</sup> pump)
  - The One-Program control system is time-based
- The Ten-Program control system (time or sensor) is optional for these models, except for S20

The One-Program control system provides only one program (P1)

- There is no memory to store additional values
- The machine starts with the values that were most-recently used
- The pump starts upon closing of the cover and stops when it is reopened

#### 7.1.1 Programmable Functions

The following function values may be customized for P1:

- Vacuum time: in seconds
- Sealing time: in seconds

#### 7.1.2 Programming

- Turn the machine on by pressing the on/off button
  - The factory setting for the vacuum time is 30-40 seconds
  - The factory settings for the seal time is 2 seconds

#### 7.1.3 Reviewing Vacuum Time and Sealing Time

- Press the button to display the programmed vacuum time  
the vacuum time is pre-set at the factory
- Press the button to display the programmed sealing time  
the sealing time is pre-set at the factory at 2 seconds

#### 7.1.4 Adjusting Vacuum Time for P1

- Press twice on the or button
  - After pressing once, the programmed value is displayed
  - After pressing twice, the symbol will start blinking and the value may be adjusted
- Save** the new value by pressing the menu button
- To retain** the original value, press the button
- Exit** the program by pressing the menu button

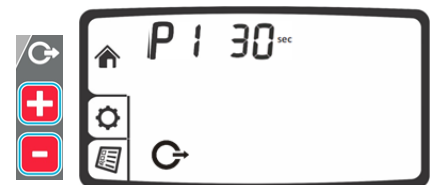

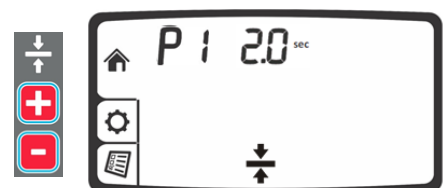

#### 7.1.5 Adjusting Sealing Time for P1

- Press twice on the or button
  - After pressing once, the programmed value is displayed
  - After pressing twice, the symbol will start blinking and the value may be adjusted
- Save** the new value by pressing the menu button
- To retain** the original value, press the button
- Exit** the program by pressing the menu button





### 7.1.6 Turning Off Machine

1. Turn the machine off by pressing the  button
2. The  symbol on the display will start blinking
3. Push the  button a second time and the pump will stop immediately
4. If no action is taken the pump turns off after 4 seconds
5. Close the cover and the machine will initiate the cool-down phase and perform a number of vacuum cycles while the cover stays closed and the machine will turn off automatically after about 15 minutes
  - These cycles are necessary to cool down the machine and to allow any moisture in the oil of the pump to evaporate

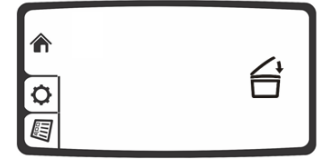





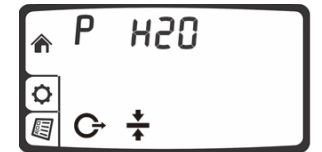
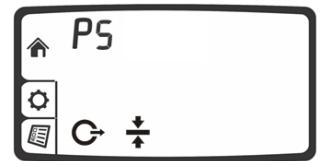

### 7.2 Ten-Program Control System

- The Ten-Program control system is standard time-based on the M20, M40-M80, L01-L60
  - sensor-based operation is an option, which can be installed at a later date
- The Ten-Program control system provides:
  1. 9 customizable programs (P1-P9)
  2. Program PA; this is an - Automatic Program – Pre-set at the factory at a vacuum time of 30-40 seconds (or 5 mbar for a sensor-based program) and a sealing time of 2 seconds
  3. Program P H<sub>2</sub>O for liquid products (see page 19)
- When turning on the machine, the pump will start. After about 15 minutes of inactivity, the pump will stop automatically







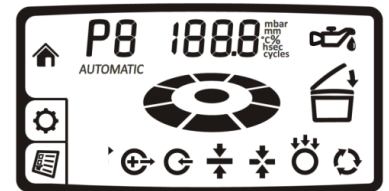

#### 7.2.1 Programmable Functions

The following functions may be customized for each program P1-P9:

-  Vacuum time: in seconds or mbar (only with sensor)
-  Sealing time: in seconds
-  Vacuum Plus: on/off, in seconds
-  Gassing: on/off, in seconds or mbar (only with sensor)
-  Clean Cut Controlled (CCC) Seal: on/off, in seconds
-  Soft-Air: on/off, in seconds or mbar (only with sensor)
-  Multi-cycle: on/off, in number of cycles







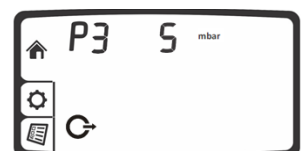
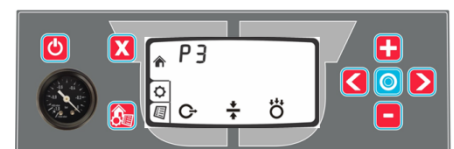





#### 7.2.2 Reviewing Function Values for P1-P9

1. Turn the machine on by pushing the  button
2. The most-recently used program will be indicated, for instance P3
3. All selected functions for this program are indicated at the bottom of the display
4. To review the values for these functions, push the  button; use the    button to display each function value
5. The values cannot be changed; this can only be done in the Settings menu
6. Push the  button to return to the Home menu





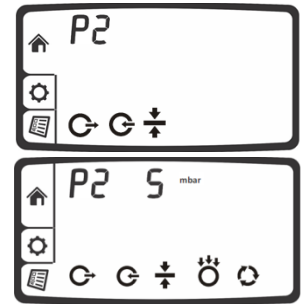

### 7.2.3 Programming and Adjusting Values for P1-P9

1. Select the program to be set up or adjusted, for instance P2
2. Push the menu button  to access the Settings menu
3. All functions for the selected program are indicated at the bottom of the display
4. Push the    button to select the blinking function to be adjusted
5. Adjust the value of the selected function with the   button
6. Press the  button to reset all functions to their original values
7. Select the next function with the    button
8. Press the menu button  to save the entered values and to return to the Home menu















### 7.2.4 Turning Program Functions ON/OFF

The following functions can be turned **ON/OFF** for each program P1-P9:

-  Vacuum Plus: on/off, in seconds
-  Gassing: on/off, in seconds or in mbar (only with sensor)
-  Clean Cut Controlled (CCC) Seal: on/off, in seconds
-  Soft-Air: on/off, in seconds or in mbar (only with sensor)
-  Multi-cycle: on/off, in number of cycles

### 7.2.5 Adjusting ON/OFF Function Values

1. Press the menu button  to select the Settings menu
2. Use the    button to select the blinking function to be adjusted
3. For instance, the gassing function is turned off. Press the  button to turn this function on
4. Press the   button to select the desired value, for instance 180 mbar
5. Press the  button to reset all functions to their original values
6. Select the next function with the    button
7. Push the menu button  to store all selected values and to return to the Home menu

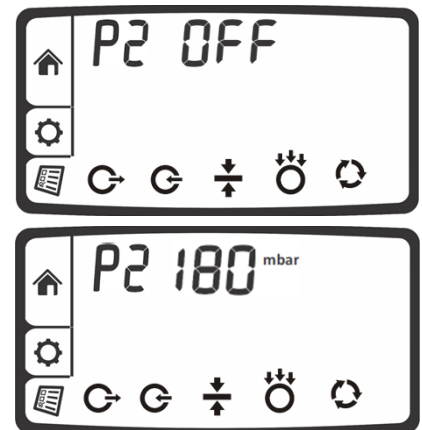

### 7.2.6 Turning Off Machine

- Follow the same procedure as for the One-Program control system, as explained on page 14



### 8.0 Symbols in the Display

- Not all symbols are visible at all times
- By **default**, the display will show the **Home** menu, indicating the program number (P1 through P9) and digital readout for actual vacuum time or pressure (mbar)
- The symbols for all selected program functions will show at the bottom of the display. The symbol for the active function will be blinking
- The remaining two symbols on the right-hand side will be visible when applicable

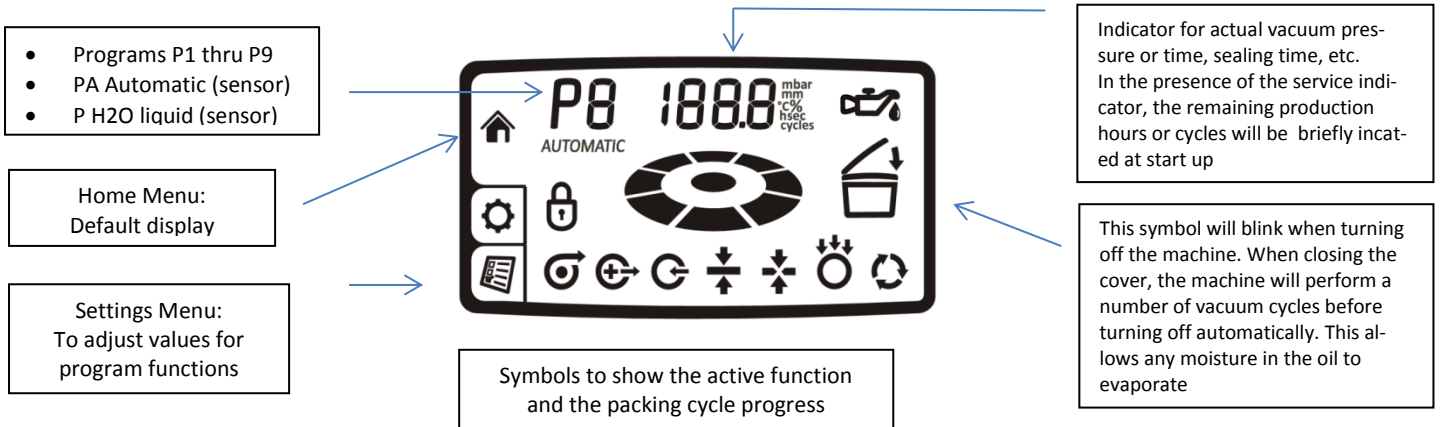

	<b>Home Menu</b> <ul style="list-style-type: none"> <li>○ Standard default display, showing the progress of the packing cycle</li> <li>○ Programmed function values can be reviewed by pushing the  button</li> </ul>
	<b>Service Menu</b> <ul style="list-style-type: none"> <li>○ Factory settings; dealer access only</li> </ul>
	<b>Settings Menu</b> <ul style="list-style-type: none"> <li>○ To enter and adjust the programmable function values</li> </ul>
<b>P8</b>	<ul style="list-style-type: none"> <li>○ P -Active-Program Display</li> <li>○ Up to 9 customizable programs may be entered and displayed</li> <li>○ The PA and P H<sub>2</sub>O programs are pre-set at the factory <ul style="list-style-type: none"> <li>○ PA = Program Automatic: This Plug &amp; Play program has factory settings for vacuum and sealing functions. The pre set values are most commonly used</li> <li>○ P H<sub>2</sub>O program: This program is specially designed for liquid products to prevent boiling and excessive evaporation</li> <li>○ P1-P9 can be individually programmed depending on the options available</li> </ul> </li> </ul>
<b>AUTOMATIC</b>	<ul style="list-style-type: none"> <li>○ Standard Plug &amp; Play program runs when turning on the machine for the first time</li> <li>○ Vacuum time or pressure, and sealing time are factory pre-set and cannot be changed</li> </ul>
<b>1888</b>	<b>Display of the value of the active function</b> <ul style="list-style-type: none"> <li>○ Displays vacuum pressure in mbar (standard) or in % (for sensor-based applications)</li> <li>○ Displays remaining vacuum time in seconds (for time-based applications)</li> <li>○ sealing time, vacuum-plus time, soft-air time or pressure, MAP time or pressure, multi-cycle count, etc.</li> <li>○ when oil change indicator is shorty shown at the start of the machine: displays remaining production hours or cycles before an oil change is required</li> </ul>
<b>mbar min °C% hsec cycles</b>	<ul style="list-style-type: none"> <li>○ Programmable in the Settings menu</li> </ul>

<b>SYMBOLS INDICATING PROGRESS OF THE PACKING CYCLE</b>	
	<p><b>Cycle Progress Indicator</b></p> <ul style="list-style-type: none"> <li>This symbol rotates during the packing cycle</li> </ul>
	<p><b>Vacuum Process</b></p> <ul style="list-style-type: none"> <li>In the presence of a sensor, the vacuum measurement is digitally displayed.</li> <li>When operating a time-based program, the vacuum measurement is indicated by the analog vacuum gauge</li> </ul>
	<p><b>Vacuum Plus</b> (page 19: 10.4)</p> <ul style="list-style-type: none"> <li>With a sensor controlled machine, a number of seconds may be added to the vacuum process after the programmed pressure value has been reached</li> </ul>
	<p><b>MAP Gassing</b> (optional; for sensor-based operation only) (page 20: 10.5)</p> <ul style="list-style-type: none"> <li>During the MAP (Modified Atmospheric Packaging) gassing process, the package is vacuated down to a programmed value, for instance 600 mbar; the vacuum measurement is shown in the display</li> <li>The gassing time count-down is displayed in seconds, or the increasing pressure is displayed in mbar or %</li> </ul>
	<p><b>Sealing</b> (page 20: 10.6)</p> <ul style="list-style-type: none"> <li>The package is heat-sealed for a programmable number of seconds (single-double-clean cut)</li> </ul>
	<p><b>Clean Cut Controlled Seal</b> (optional) (page 20: 10.6)</p> <ul style="list-style-type: none"> <li>Special sealing method, by which a second heating wire scores the package, making it easy to remove the excess packaging material</li> <li>The additional wire is time-controlled independently; the scoring time is displayed</li> </ul>
	<p><b>Soft-Air</b> (optional) (page 21: 10.8)</p> <ul style="list-style-type: none"> <li>The vacuum chamber is aerated more slowly. This allows the packaging material to gradually conform to irregularly-shaped products and prevents sharp objects from puncturing the bag</li> <li>The aeration time count-down is displayed in seconds, or the gradually increasing pressure is displayed in mbar or %</li> </ul>
	<p><b>Multi-Cycle</b> (for MAP applications only) (page 21: 10.9)</p> <ul style="list-style-type: none"> <li>After the package is vacuated down to the programmed value, it is gassed and re-vacuated a number of times. The objective of this procedure is to minimize the amount of oxygen remaining in the package</li> <li>The number of cycles is counted down in the display</li> </ul>

	<p><b>Cool-Down/Oil Dehumidification Phase</b> (page 21: 10.10)</p> <ul style="list-style-type: none"> <li>When turning off the machine with the  button, the symbol will start blinking in the LCD display and the pump will stop after about 4 seconds</li> <li>Press the  button a second time and the pump will stop immediately</li> <li>Close the lid and the machine will initiate the cool-down phase by performing a number of vacuum cycles before turning off automatically</li> <li>These additional cycles allow any moisture in the oil of the pump to evaporate. This increases the longevity of the machine and minimizes the need for oil changes and maintenance</li> </ul>	
	<p><b>Service Indicator: Oil Change</b></p> <ul style="list-style-type: none"> <li>After a number of operating hours or packing cycles, the service symbol will <u>briefly appear</u> on the display when turning on the machine. In addition, the display will indicate how many hours or cycles remain before an oil change is required</li> <li>After reaching zero, the display will indicate the negative number of exceeded operating cycles or hours</li> <li>To reset the service interval counters after the oil change: Start machine  and while the display shows the hours or cycles, press and hold the  button</li> </ul>	

## 9.0 Standard Vacuum Pump Settings:



### 1. Pump stops after vacuum cycle

### 2. Pump runs continuously; stops after 15 minutes

- The pump of mobile packaging machines M10, M20 and M40, M50, M60, M70, M80, as well as the pump of double-chamber units L10, L30, L40 en L60, runs continuously. After completion of a packing cycle, the pump will stop after 15 minutes of inactivity.
- The pump of table units S20, S30, S40 and S50 starts when the cover is closed; the pump stops when the cover is opened again.
- The 21m3 pump of the M30 continues to run, while the 40m3 pump stops between packing cycles
- These settings may be adjusted by the dealer in the Service menu

## 9.1 One-Program Control System



### Stop the cycle and aerate:

- By pressing the button during the packing cycle, the active function is stopped, the chamber is aerated and the cover opens. Subsequent functions in the cycle are cancelled

### Stop the cycle and start sealing

- By pressing the of the sealing button , the vacuum function is interrupted and the program jumps to the sealing function

## 9.2 Ten-Program Control System



### Stop the cycle and aerate:

- By pressing the button during the packing cycle, the active function stops, the chamber is aerated, and the cover opens. Subsequent functions in the cycle are cancelled

### Stop the cycle and start sealing

- By pressing the button, the packing cycle is interrupted and the program jumps to the next function in the process

## 10.0 Further Explanation of Packaging Concepts

### 10.1 Sensor-Based Control

The actual air pressure in the chamber is measured by a sensor. The result of this measurement is digitally indicated on the LCD display.

Normal air pressure is about 1000 mbar. The vacuum pump of the machine reduces this to about 2-5 mbar. Depending on the program, the pressure by which certain functions need to take place can be programmed. Examples are MAP gassing and Soft-Air.

The air pressure in time-controlled machines is indicated by the analog vacuum gauge.

### 10.2 Time-Based Control

- The standard control of a One-Program machine, as well as a Ten-Program machine, is time-based
- The Ten-Program time based machine can be converted into sensor-based operation by ordering the optional sensor kit

A time-controlled machine is programmed with a time value in seconds, according to which a desired vacuum is reached. The vacuum measurement is indicated by the analog vacuum gauge. The reading of the analog vacuum gauge is less accurate than the digital reading of a sensor-controlled machine.



- The Ten-Program machine can be retro-fitted with a sensor kit at a later date. The control system recognizes the sensor and will automatically switch over to sensor-based operation
- In case the sensor should fail, the machine will automatically switch over to time-based operation



### 10.3 P H<sub>2</sub>O Program for Liquid Products

- Only for Ten-Program machines with sensor-based control
- Specially designed for the packaging of cooled liquid products like sauces and soups at temperatures < 15°C (60°F)

Under normal air pressure (1000 mbar), water boils at 100°C. At that point, water transfers rapidly from a liquid phase to a gas phase. At lower air pressure, boiling starts at a lower temperature as well as rapid evaporation. To avoid product loss through evaporation and spillage, the P H<sub>2</sub>O program detects the point of boiling and initiates sealing function in the cycle. Since air is replaced by water vapor at this point, the oxygen content in the package will be very low.

### 10.4 Vacuum Plus (seconds)

- Only for Ten-Program machines with sensor-based control
- Can be turned on or off in the Settings menu 

After reaching a programmed vacuum pressure, the sealing function may be delayed by adding a programmable number of seconds to the vacuum process. This enables any air to escape from porous products.

### 10.5 MAP Gassing (option)

- Only for Ten-Program machines with sensor-based control
- Can be turned on or off in the Settings menu 

After reaching a programmed vacuum pressure, the package is filled with an inert gas, such as CO<sub>2</sub>, nitrogen, oxygen, or a mixture thereof. This feature is either time or pressure-controlled.



## 10.6 Sealing ✦

The synthetic packaging material is melted shut by a heated sealing wire.

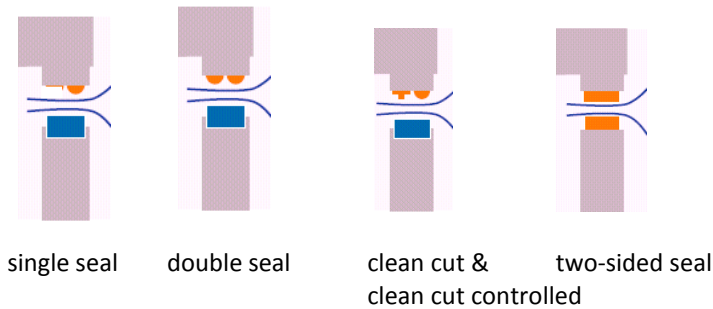

- **Single Seal**  
Only for S20. The package is sealed with a single sealing wire
- **Double Seal**  
All other machines are equipped with a double sealing wire
- **Clean Cut Seal (CC Seal)**  
One of the two heated wires is used to score the package. This makes it easy to remove the excess packaging material. The package has one seal and a nicely trimmed edge.

- **Clean Cut Controlled Seal (CCC Seal) ✦**
  - Only for Ten-Program machines with sensor-based control
  - Can be turned on or off in the Settings menu 

Identical to the Clean Cut seal, with the only difference that the heating time for the scoring wire can be programmed independently. This improves control over the scoring process. Typically used for shrink bags.

- **Two-Sided Seal**
  - Only for Ten-Program machines with sensor-based control
  - Can be turned on or off in the Settings menu 

The counter beam contains a sealing wire as well. Used for thick material or metallic packaging materials, requiring additional heat to seal the bags.

## 10.7 Extra Sealing Pressure

During the sealing process, the package is held in place between the seal beam and the counter beam. To assure a proper package seal, additional air pressure to the sealing beam may be beneficial (maximum of 1 bar), for instance during MAP gassing above 500 mbar.

- The M40-M80 and the I10-L60 models with the option Gas/MAP are **standard equipped** with a compressed air inlet. Otherwise it can be easily retrofitted.
- Extra sealing pressure is not necessary and not available for the Table-Top, M10, M20, M30



### 10.8 Soft-Air (option)

- Only for Ten-Program machines with sensor-based control
- Can be turned on or off in the Settings menu 

After the vacuum and sealing process, the chamber is aerated and brought back to ambient air pressure. Since this happens quickly, the packaging material conforms to the product quickly as well. If the product has sharp edges, the packaging material may be punctured during this process. With the Soft-Air feature, air is introduced into the vacuum chamber in a slower and controlled manner. As a result, the packaging material gradually conforms to the product, thus avoiding damage. This feature is either time or pressure-controlled. Machines with a Ten-Program control system can be retro-fitted with this feature.



### 10.9 Multi-Cycle

- Only for Ten-Program machines with sensor-based control
- Can be turned on or off in the Settings menu 
- Only in combination with MAP gassing

This option minimizes the amount of oxygen in the product. The machine vacuates and gases the package several times in a row, thus flushing air and oxygen from the chamber and the package. This feature is used for delicate products that do not permit vacuation down to 5 mbar, while at the same time requiring a low oxygen content.

### 10.10 Cool-Down/Oil Dehumidification of the vacuum pump

During the vacuum process, moisture is removed from the product through evaporation. This moisture can be absorbed by the oil of the vacuum pump. Too much moisture in the oil will reduce the effectiveness of the pump. In addition, it will reduce the lubrication properties of the oil, affecting the longevity of the pump. Heat and ventilation will dissipate this moisture, for which reason it is important to let the pump run for some time at the end of production.

- Turn the machine off with the  button and close the cover when the  symbol starts blinking. The pump will continue to run for some time, before turning off automatically. This allows any moisture in the oil of the pump to evaporate





## 11.0 Maintenance

### 11.1 General

Regular maintenance prevents equipment malfunctions and prolongs the life of the machine. In addition, it optimizes sanitary conditions.

- Always have a certified Turbovac dealer carry out repair and maintenance activities



#### Warning

- During maintenance activities, always turn the machine off at the main switch and/or unplug it from the electrical outlet



#### Attention



Observe the recommended service intervals. Overdue maintenance may lead to costly repairs and overhauls, and may void the equipment warranty

- After reaching a programmed number of operating hours or packing cycles, the service symbol  will briefly appear on the display when the machine is started up. In addition, the display will indicate how many hours or cycles remain before an oil change is required
- After passing the service limit, the display will indicate the negative number of excess operating hours or cycles





### 11.2 Vacuum Pump

To protect the vacuum pump, proper maintenance is important. Carry out the following tasks carefully:

- Check the vents and clean as necessary before turning on the machine to assure proper cooling of the pump
- When the air filter is saturated with oil, an oil mist may be expelled; replacement of the filter is required
- Use the cool-down/dehumidification feature. When turning off the machine  and closing the cover , the pump continues to run for some time. Any moisture in the oil of the pump will evaporate during this phase. This increases the longevity of the machine and minimizes the need for oil changes and pump maintenance
- Check the oil level regularly and add as needed
- Change the oil when the service symbol  appears on the display



#### Note

To reset the service interval counters after the oil change: Start machine  and while the display shows the hours or cycles, press and hold the  button



### 11.3 Adding and Changing the Pump Oil



#### Warning

The operating temperature of the pump is 70° C / 158° F or higher. Wear gloves when servicing the pump or let it cool off sufficiently to prevent injuries.

Table Models

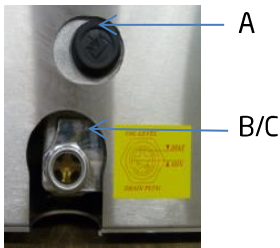

Mobile or Double-Chamber Models

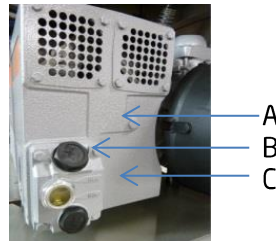

A	Oil filler cap
B	Oil sight glass
C	Oil drain plug



#### Recommended Oil Types

Recommended Oil Types DIN 51506	Pumps
HLPT 22	4m <sup>3</sup>
VG032	8m <sup>3</sup> - 16m <sup>3</sup> - 21m <sup>3</sup> 1-phase pump
VG068	40m <sup>3</sup> - 63m <sup>3</sup> 1-phase pump
VG 100	40m <sup>3</sup> - 300m <sup>3</sup> 3-phase pump

#### Adding Oil

1. Remove the oil filler cap
2. Add oil up to the maximum-level mark; use oil according to DIN 51506, lubrication oil group VC; See 'Technical Specifications' for additional information. When in doubt, consult your dealer
3. Replace the oil filler cap
4. After several packing cycles, check the oil level and add as needed

#### Changing Oil

1. Remove the oil drain plug and drain the oil
2. Replace the drain plug
3. Remove the oil filler cap
4. Add the correct oil up to the maximum-level mark
5. Replace the oil filler cap
6. To reset the service interval counters after the oil change: Start machine  and while the display shows the hours or cycles, press and hold the  button



#### Note

Collect the oil to have it processed and recycled according to the locally applicable regulations

### 11.4.0 Seal Beams and Counter Beams

To achieve a quality seal, it is necessary that the seal beam and counter beam are in good condition.

1. Clean the seal and counter beams daily with a dry cloth
2. Replace the Teflon tape on the seal beam if damaged and replace the sealing wire if kinked
3. Replace the silicone rubber seal if it is burned in

Depending on the type of machine, there are **three seal beam versions**:

1. Single-seal beam (T2)
2. Stainless steel seal beam
3. Aluminum seal beam

#### 11.4.1 Single-Seal Beam

**Remove the sealing wire and Teflon tape as follows:**

1. Grab the seal beam in the middle and pull it straight up and out of the machine
2. The beam is held in place by 2 pins; some force may be necessary to loosen the beam
3. Remove the brown Teflon tape (A) that is applied to the seal beam
4. Remove the two screws (F) on the underside of the seal beam; this releases the sealing wire (B)
5. Clean the seal beam thoroughly and remove any glue residue of the Teflon tape



#### Notes

- Check the condition of the tensioning springs (D) at both ends of the seal beam; replace if necessary
- These springs maintain tension on the sealing wire
- Using the seal beam without the springs may cause sealing wires to break

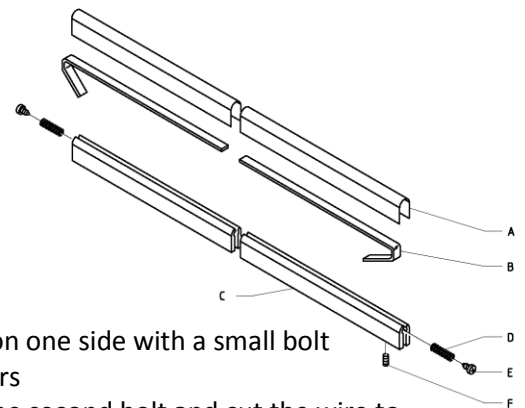

**Install the sealing wire and Teflon tape as follows:**

1. Position the sealing wire across the beam and fasten it on one side with a small bolt
2. Apply tension on the wire by pulling it with a pair of pliers
3. Fasten the wire on the opposite end of the beam with the second bolt and cut the wire to length; the ends of the sealing wire must be long enough to make electrical contact with the pins in the vacuum chamber
4. Apply the Teflon tape smooth and tight over the seal beam; make sure that the beam is clean and free of grease
5. Re-install the beam in the vacuum chamber; check to make sure that the ends of the sealing wire make contact with the steel pins

## 11.4.2 Aluminum/Stainless Steel Seal Beam

### Remove the sealing and cutting wires as follows:

1. Remove the old wires by pulling them loose from the seal beam contacts
2. Loosen the clamp screws and remove the seal beam from the U-profile
3. Remove the Teflon tape from the seal beam
4. Remove the mounting plates (C) on both ends of the seal beam by loosening the screws; this releases the sealing wires (B) and/or sealing and cutting wires
5. Clean the seal beam thoroughly



### Notes

- After removal of the wires, check the strips of fiber glass(A) for damage; replace if necessary
- Check the condition of the tensioning springs (D) at both ends of the seal beam; replace if necessary.
- Using the seal beam without the springs may cause the sealing wires to break
- Check contact plate (E) for damage; replace if necessary

### Install the sealing and cutting wires as follows:

1. If necessary, install new strips of fiber glass on the seal beam
2. Insert the new wires (B) behind one of the mounting plates (C) and tighten the screws (D); make sure that the end of the wires line up with the bottom edge of the mounting plate
3. Position the wires across the seal beam and loosely install the second mounting plate
4. Carefully clamp the seal beam upside down in a bench vice
5. Pull the wires as tightly as possible with a pair of pliers (A) and secure the second mounting plate (D) by tightening the screws

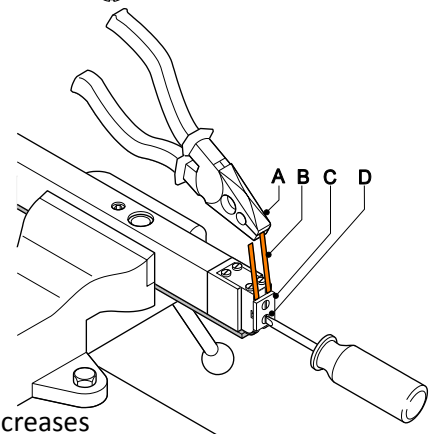
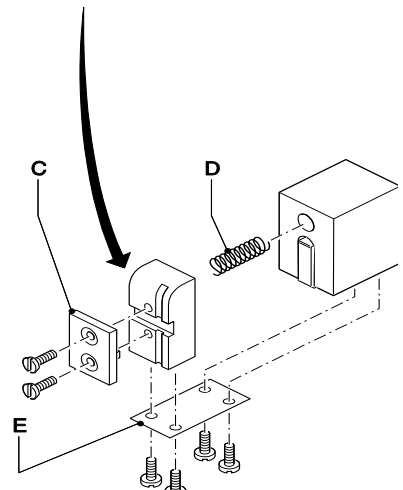
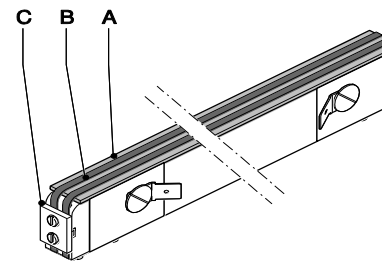

### Note

1. The wires can be further tightened by slightly loosening the screws of one of the mounting plates
2. Pull the wires one-by-one tighter with a pair of pliers;
3. Re-tighten the screws after the correct tension has been achieved
4. Cut the end of the wires flush with the bottom edge of the mounting plate
5. Apply the Teflon tape smooth and tight over the seal beam without creases  
 Make sure that the beam is clean and free of grease
6. Re-install the seal beam in the vacuum chamber and re-connect the wires

### 11.4.3 Aluminum T-Shaped Seal Beam

#### Remove the sealing wires as follows:

1. Remove the seal beam from the machine
2. Remove the Teflon tape
3. Loosen the screws (D) on both sides of the beam; this will release the sealing wires (B)
4. Clean the seal beam thoroughly

#### Install the sealing wires as follows:

1. Apply new fiber glass (A) to the beam if necessary
2. Place new wires (B) on the beam and fasten them on one side with mounting plates (C); tighten the screws (D)
3. Position the wires across the beam
4. Fasten mounting plates (C); tighten screws (D)
5. Carefully clamp the beam in a bench vice
6. Pull the wires as tightly as possible with a pair of pliers
7. secure the mounting plates (C) with the screws (D)

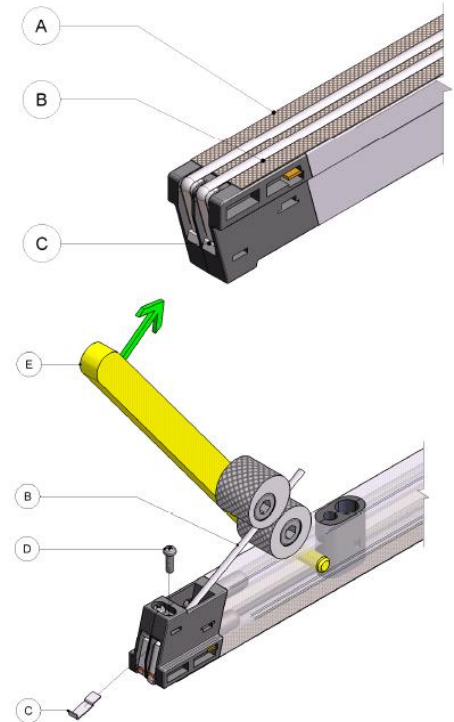

#### Notes

- Check the strip of fiber glass(A) for damage and replace if necessary
- Check the springs and replace if necessary
- Using the seal beam without the springs may cause the sealing wires to break

### 11.4.4 Applying Teflon Tape to Seal Beam

1. Position the new Teflon tape (A) on the seal beam and
2. Cut out the corners (C)
3. Remove the protective backing from the Teflon tape
4. Apply the new tape to the seal beam (B); the tape has an adhesive strip on both sides
5. Slide the seal beam onto the pins in the vacuum chamber (machines with transparent cover)
6. Slide the seal beam in the holder of the cover, tighten the mounting screws, and re-connect the wires (machines with metal cover)

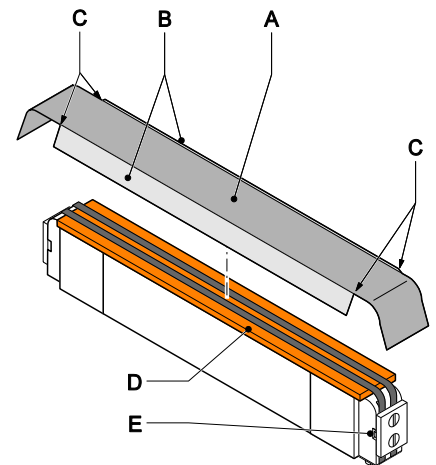

#### Note

- The Teflon tape must not adhere to the tension blocks (E)

### 11.5 Replacing Silicone Rubber Seal of Counter Beam

The rubber seal is clamped in the counter beam.

**Replace the counter beam seal as follows:**

1. Pull the old rubber seal from the groove in the counter beam
2. Clean the groove
3. Evenly press the new rubber seal into the groove and make sure that it does not stick out at either end of the counter beam

### 11.6 Rubber Seal of Vacuum Chamber Cover

To assure that the vacuum chamber is properly sealed, it is important that the rubber seal is in good condition and is not damaged.

**Replace the cover seal as follows:**

1. Copy the length of the original rubber seal
2. Pull the original rubber seal from the groove
3. Clean the groove
4. Evenly press the rubber seal into the groove;  
position the ends of the seal tightly against each other to prevent leakage

### 11.7 Struts, Dampers and Springs

- Machines with transparent covers are equipped with gas struts to open the cover
- Machines with metal covers are equipped with oil dampers and springs to open the cover
- Have the struts, dampers and springs checked by your dealer once every 5 years and have them replaced as necessary
- Have the gas struts replaced if the lid no longer opens properly

### 11.8 Vacuum Hoses and Tubes

- Check the vacuum hoses and tubes for kinks, tears and porosity; replace if necessary

## 12.0 Malfunctions and Notifications

- In case the machine has technical problems, please use the check list below to see if you can resolve the malfunction yourself
- If technical support is required, please contact your dealer
- You may also contact us, so that we can assist you in locating your nearest dealer +31 73 627 12 73 or by e-mail info@turbovac.nl

## 12.1 Service and Technical Support

Please have the following information available:

- **Machine type**
- **Serial number**

You can locate this information on the identification plate on the right-hand side or back-side of your machine.

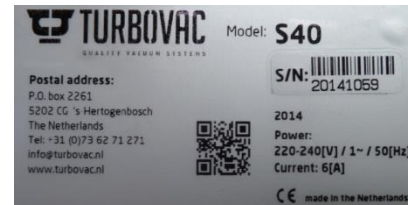





## 12.2 YouTube Turbovac Channel - Instruction and Service Videos

Instructional videos are placed on YouTube for the operation and service of your machine. You may locate these videos on the YouTube website under "Turbovac Channel".

## 12.3 Trouble Shooting Check List

Fault/Symptom	Possible Cause	Remedy
Machine does not work	The machine is not plugged in	Plug the machine into the electrical outlet
	The ground fault safety in the electrical panel has tripped	Check the electrical panel
	A fuse in the electrical panel is faulty	Check the electrical panel
	A fuse in the machine is faulty	Consult your dealer
	The motor protection of the machine is switched off	Consult your dealer
The vacuum pump does not run at full speed	The oil is too thick or contaminated	Change the oil. Page20: 10.2
	The pump motor runs on two phases	Check the voltage; if correct, consult your dealer
The vacuum in the package is insufficient	The programmed vacuum value is too high	Lower the vacuum value in the program
	The packaging material is of poor quality	Select a better-quality packaging material
	The product damages the bag	Program a higher value for Soft-Air
	The machine gases the package	Turn off the gassing function
The seal is leaking	The package seam is poorly formed	Increase the sealing time and/or reduce the MAP gas pressure
	The package seam is burnt	Decrease the sealing time
	The opening of the vacuum bag is contaminated	Try again and make sure that the opening of the bag stays clean
	The sealing beam is dirty	Clean the sealing beam
	The Teflon lining of the sealing beam is damaged	Replace the Teflon lining
	The silicon rubber seal in the counter beam is damaged	Replace the silicon rubber seal



There is not enough gas in the bag	The bag is too small	Select a bigger bag
	The programmed gas level is too low	Increase the gas level value
	The bag is not correctly positioned over the gas outlets	Adjust the bag position
The machine does not seal	The bag is not correctly positioned over the sealing beam	Adjust the bag position
	The sealing wire is broken	Replace the sealing wire
	The thermal safety of the power supply was tripped	Wait until the safety resets, which can take half an hour. Decrease the sealing time
	The electrical contacts of the seal beam have fouled	Remove the seal beam and clean the pins and contacts with sand paper
The service symbol  appears when turning on the machine, indicating the remaining production hours or cycles	The service interval counters have reached their maximum programmed values 	To reset the service interval counters after the oil change: Start machine  and while the display shows the hours or cycles, press and hold the  button

### 13.0 Recommended Spare Parts

Part No.	Description
	<b>Seals</b>
9705.00040	Silicon T-profile (Length 5mtr)
9705.00045	Sealing Wire 3,5 x 0,3 (Convex, length 5mtr)
9705.00050	Sealing Wire Ø1,1 (Clean Cut, length 5mtr)
9705.00055	Teflon Tape (Length 5mtr)
11.09.0.0040	Sealing Wire 5 x 0,2 (Flat)
11.09.0.0040	Sealing Wire 8 x 0,2 (Flat)
	<b>Pump Parts</b>
03.01.1.0020	Oil exhaust filter for 021m <sup>3</sup> /h
03.01.0.0160	Oil exhaust filter for 016m <sup>3</sup> /h
03.01.1.0080	Oil exhaust filter for 040m <sup>3</sup> /h
03.01.1.0030	Oil exhaust filter for 063 and 100m <sup>3</sup> /h
03.01.1.0040	Oil exhaust filter for 160 and 300m <sup>3</sup> /h
03.01.1.0170	Oil filter for 040, 063 and 100m <sup>3</sup> /h
03.01.1.0060	Oil filter for 160 and 300m <sup>3</sup> /h
03.01.1.0220	Oil ISO VG32 (1 Ltr)
03.01.1.0120	Oil ISO VG100 (1 Ltr)
0301.00000	Oil ISO VG100 (1 Ltr) PRIVATE
	<b>Miscellaneous</b>
9705.00035	Seal 8mm for transparent lid (Length 5mtr)
0504.00045	Silicone profile for stainless steel cover



## 14.0 Utilities

Electrical	
Voltage, current, frequency	See identification plate
Maximum voltage tolerance	- 10% to + 10%

Gas (optional)	
Maximum allowable pressure	1 bar
Composition	No explosive , corrosive, caustic and/or contaminated gases
Connection	Hose coupling, 8mm for compressed air / 10mm for MAP gas

External sealing pressure (optional)	
Maximum allowable pressure	1 bar
Composition	Clean, dry compressed air
Connection	Hose coupling, 8mm

### 14.1 General Data

Recommended Oil Types DIN 51506	Pumps
HLPT 22	4m <sup>3</sup>
VG032	8m <sup>3</sup> - 16m <sup>3</sup> - 21m <sup>3</sup> 1-phase pump
VG068	40m <sup>3</sup> - 63m <sup>3</sup> 1-phase pump
VG 100	40m <sup>3</sup> - 300m <sup>3</sup> 3-phase pump

Ambient Conditions	
Ambient temperature	+ 5 to + 30° C / 41 to + 86° F
Transport temperature	- 25 to + 55° C / - 13° F to + 131° F
Positioning	Inside, level, unobstructed

## 15.0 Commonly-Used Symbols

The following pictograms and symbols are applied to your machine:



### WARNING

First consult the user manual regarding:

- Connecting the gas
- Connecting the compressed air



### WARNING

- Risk for electric shock; before opening, remove the plug from the outlet
- Access by certified personnel only



Connection for compressed air



Connection for MAP gas

## 16.0 CE-DECLARATION OF CONFORMITY

CE-KONFORMITÄTSERKLÄRUNG  
DECLARATION DE CONFORMITÉ CE  
DICHIARAZIONE DI CONFORMITA'CE

Wij,  
We, Henkovac International B.V.  
Wir, Het Sterrenbeeld 36, 's-Hertogenbosch  
Nous, The Netherlands  
Noi,

verklaren geheel onder eigen verantwoordelijkheid dat de producten,  
declare under our sole responsibility that the products,  
erklären in alleiniger Verantwortung, daß die Produkte,  
déclarons sous notre responsabilité, que les produits,  
Dichiariamo sotto la nostra responsabilità che las macchinas

### Turbovac vacuum packing machines

waarop deze verklaring betrekking heeft, in overeenstemming is met de volgende Europese Richtlijnen:  
to which this declaration relates, complies with the requirements of the following European Directives:  
auf die sich diese Erklärung bezieht, folgende Europäischer Richtlinie entspricht:  
auquel se réfère cette déclaration, est conforme aux Directives Européennes:  
alla quale si riferisce questa dichiarazione, è conforme alle Direttive Europee:

**the machine guideline: 2006/ 42/EG**

**the EMC-guideline: 2004/108/EG**

Conformiteit is aangetoond door overeenstemming met de volgende normen:  
Conformity is demonstrated by complete adherence to the following standards:  
Die Übereinstimmung wird nachgewiesen durch die vollständige Einhaltung folgender Normen:  
La conformité est démontrée par la conformité intégrale avec les normes suivantes:  
La conformità è dimostrata dalla conformità alle sequenti norme:

**NEN-EN-ISO 12100-1**  
**NEN-EN-ISO 12100-2**  
**NEN-EN-ISO 14121-1**  
**NEN-EN-ISO 13857**  
**NEN-EN-ISO 60204-1**



E.H. Goudsmid  
Managing Director

The Netherlands, 's-Hertogenbosch, Januari 2014



**02 9452-3566**

**sales@getpacked.com.au**