

Serial no.
1706302

PackMATE

PNEUMATIC CARTON STAPLER

MODEL: PCS3522A

5-STAP-PCS-35

MANUAL

WARNING

BEFORE OPERATING THIS STAPLER. ALL OPERATORS SHOULD STUDY THIS MANUAL, TO UNDERSTAND AND FOLLOW THE SAFETY WARNINGS AND INSTRUCTIONS. KEEP THESE INSTRUCTIONS WITH THE STAPLER FOR FUTURE REFERENCE. IF YOU HAVE ANY QUESTION, CONTACT YOUR DISTRIBUTOR.

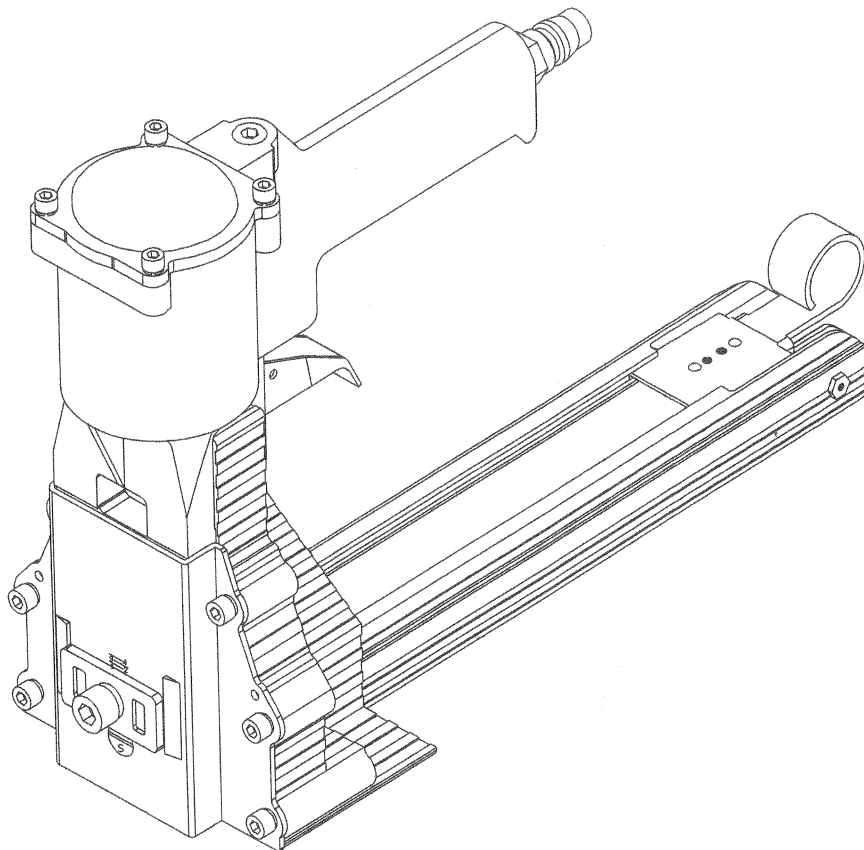

02 9452-3566
sales@getpacked.com.au

TABLE OF CONTENTS

	PAGE
TOOL SPECIFICATIONS	3
SAFETY INSTRUCTIONS	4
LUBRICATION AND MAINTENANCE	5
AIR SUPPLY AND CONNECTIONS.....	5
LOADING THE TOOL	6
CHECK STAPLE LEG LENGTH	7
CLINCH ADJUSTMENT	8
DEPTH ADJUSTMENT	8
OPERATING THE TOOL.....	9
CLEANING THE TOOL	10
CLEARING A JAM FROM THE TOOL	11
TROUBLE SHOOTING	12
TEETH REPLACEMENT	13
DRIVER REPLACEMENT	14
PUSHER SPRING REPLACEMENT.....	15
VALVE'S AND TUBE'S O-RINGS REPLACEMENT.....	16
PISTON REPLACEMENT	17
PARTS LIST	18
EXPLODED VIEW OF TOOL.....	19

TOOL SPECIFICATIONS

MODEL OF TOOL

DIMENSIONS (LENGTH x HEIGHT x WIDTH)340MM x 220MM x 150MM

WEIGHT (WITHOUT FASTENERS)2.65 KGS

WEIGHT (WITHOUT FASTENERS)1/4" NPT

COMPRESSED AIR :

MAXIMUM PERMISSIBLE OPERATING PRESSURE8 KG/Cm²

RECOMMENDED OPERATING PRESSURE5 KG/Cm² – 7 KG/Cm²

AIR CONSUMPTION0.067 M³ / MIN (2.4 C.F.M)
WITH 60 STAPLES PER MINUTE
@5.66 KG/CM²(80 PSI)

STAPLES SPECIFICATIONCROWN MM
LENGTH 15MM, 18MM (ADB-19)

STAPLES SPECIFICATIONCROWN MM
LENGTH 18MM, 22MM (ADB-22)

STAPLES CAPACITY 100 PCS

THE NOISE LEVELS: (AT THE WORKPLACE, ALWAYS WEAR HEARING PROTECTION EQUIPMENT.)

A-EIGHTED SINGLE-EVENT SOUND PRESSURE LEVEL AT OPERATOR'S POSITION: **L Pa, 1s = 89 dBA**

A-WIGHTED SINGLE-EVENT SOUND POWER LEVEL **L WA, 1s = 93 Dba**

A-WIGHTED SINGLE-EVENT SURFACE SOUND PRESSURE LEVEL **L Pa, 1s, 1m=80 dBA**

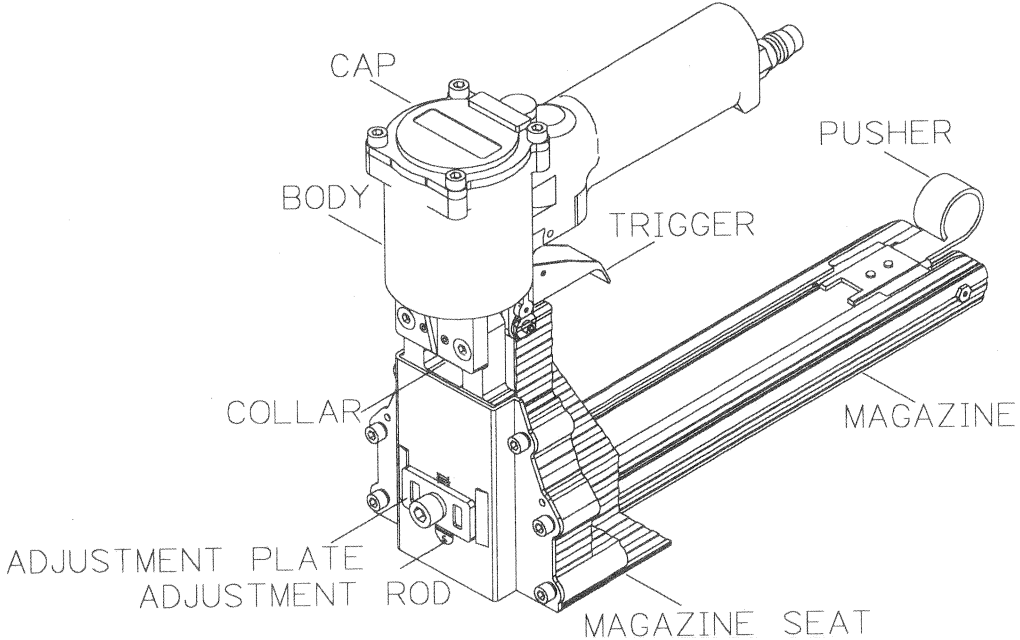

SAFETY INSTRUCTIONS

DANGER

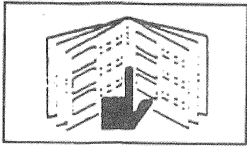

1. READ THIS MANUAL AND UNDERSTAND ALL SAFETY INSTRUCTIONS BEFORE OPERATION THE TOOL. IF YOU HAVE ANY QUESTIONS , PLEASE CONTACT OUR AU . THORIZED REPRESENTATIVES .

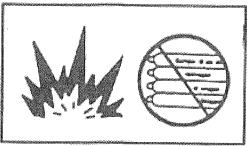

2. NEVER ALLOW TO USE TYPE OF FLAMMABLE GASES OXYGEN AS A POWER SOURCE FOR THE TOOL . USE FILTERED , LUBRICATED , REGULATED , COMPRESSED AIR ONLY .



3. NEVER USE GASOLINE OR OTHER FLAMMABLE LIQUIDS TO CLEAN THE TOOL . VAPORS IN THE TOOL WILL IGNITE BY A SPARK AND CAUSE THE TOOL TO EXPLODE .



4. DO NOT EXCEED MAXIMUM PERMISSIBLE OPERATING PRESSURE OF THE TOOL (8 kg/cm²) .

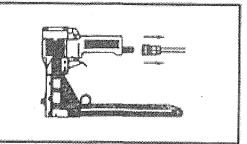

5. DISCONNECT THE TOOL FROM AIR SUPPLY BEFORE CLEANING JAMS , SERVICING , ADJUSTING , AND DURING NON-OPERATION .

WARNING



6. DO NOT PULL THE TRIGGER WHEN CARRYING OR HOLDING THE TOOL . NEVER CARRY THE TOOL BY THE HOSE OR PULL THE HOSE TO MOVE THE TOOL.

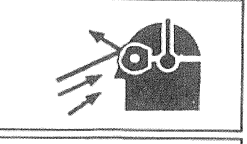

7. AT THE WORKPLACE , ALWAYS WEAR THE PROTECTIVE EQUIPMENT SUCH AS SAFETY GLASSES , HEARING PROTECTION AND HEAD PROTECTION .

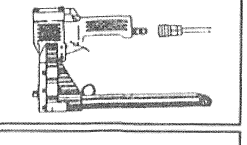

8. DO NOT USE A CHECK VALVE OR ANY OTHER FITTING WHICH ALLOWS AIR TO REMAIN IN THE TOOL .



9. DO NOT PLACE YOUR HAND OR ANY PART OF YOUR BODY IN THE STAPLE CLINCHING AREA OR ADJUSTMENT WINDOW OF THE TOOL WHEN CONNECTING OR DISCONNECTING AIR SUPPLY .



10. NEVER POINT ANY OPERATIONAL DRIVING TOOL AT YOURSELF OR AT ANY OTHER PERSON .

LUBRICATION AND MAINTENANCE

NOTE



- YOUR TOOL REQUIRES LUBRICATION BEFORE YOU USE IT FOR THE FIRST TIME .
- DISCONNECT THE AIR SUPPLY FROM THE TOOL BEFORE LUBRICATING .

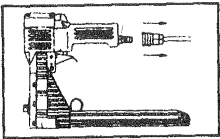

- TURN THE TOOL SO THE INLET IS FACING UP AND PUT ONE DROP OF HIGH SPEED SPINDLE OIL , UNOCAL RX22 , OR 3-IN-1 OIL INTO AIR INLET . NEVER USE DETERGENT OIL OR ADDITIVES . OPERATE THE TOOL BRIEFLY AFTER ADDING OIL .

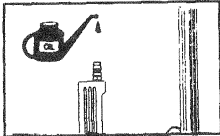

- WIPE OFF EXCESSIVE OIL AT THE EXHAUST , EXCESSIVE OIL WILL DAMAGE ORINGS OF TOOL . IF IN-LINE OILER IS USED. MANUAL LUBRICATION THROUGH THE AIR INLET IS NOT REQUIRED ON A DAILY BASIS .

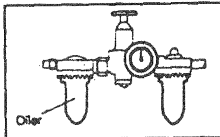

AIR SUPPLY AND CONNECTIONS

NOTE

THE FOLLOWING ILLUSTRATION SHOWS THE CORRECT MODE OF CONNECTION TO THE AIR SUPPLY SYSTEM WHICH WILL INCREASE THE EFFICIENCY AND USEFUL LIFE OF THE TOOL.

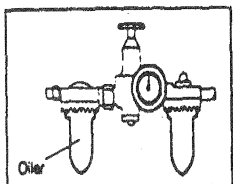
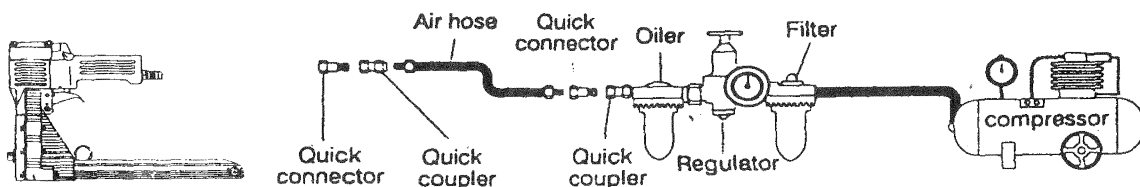

- MANY AIR TOOL USERS FIND IT CONVENIENT TO USE OILER TO HELP PROVIDE OIL CIRCULATION THROUGH TOOL AND INCREASE THE EFFICIENCY AND USEFUL LIFE OF THE TOOL . CHECK OIL LEVEL IN THE OILER DAILY .

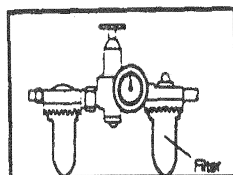

- MANY AIR TOOL USER FIND IT CONVENIENT TO USE A FILTER TO REMOVE LIQUID IMPURITIES WHICH CAN RUST OR WEAR INTERNAL PARTS OF THE TOOL . A FILTER ALSO INCREASE THE EFFICIENCY AND USEFUL OF THE TOOL . THE FILTER MUST BE CHECKED ON A DAILY BASIS AND IF NECESSARY DRAINED .

LOADING THE TOOL

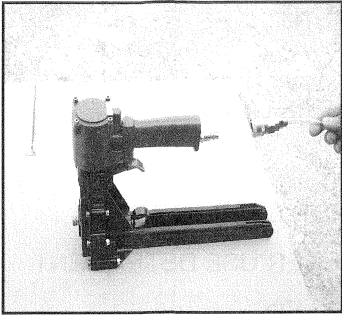

DISCONNECT THE AIR SUPPLY.

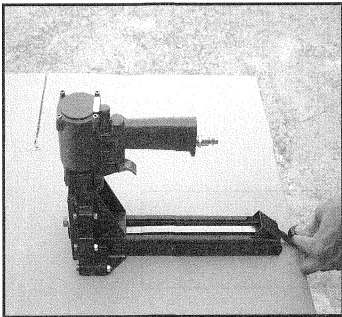

PULL PUSHER (036) BACK UNTIL IT STOPS ON PUSHER PIVOTS (032) THEN ROTATE PUSHER (036) TO POSITION .

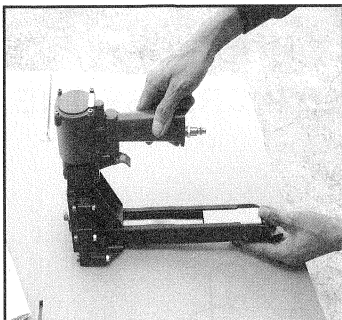

INSERT 2 STICKS OF APPROPRIATE STAPLES INTO THE MAGAZINE (030) FROM BACK . LET THE STICKS SLIDE FORWARD TO THE FRONT OF THE MAGAZINE (036)

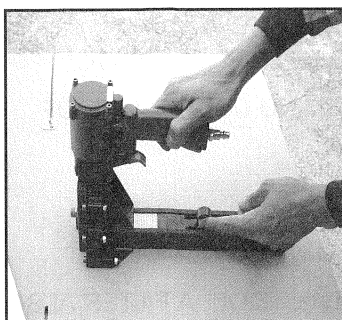

PULL PUSHER (036) BACK TO UPRIGHT POSITION AND GENTLY LET THE PUSHER (036) SLIDE FORWARD AGAINST THE STAPLES . DO NOT LET THE PUSHER (036) SLIDE FORWARD AND STRIKE THE STAPLES AT HIGH SPEED FOR THIS MAY DEFROM THE STAPLES OR DAMAGE THE TOOL .

CHECK STAPLE LEG LENGTH

NOTE : DISCONNECT THE AIR SUPPLY

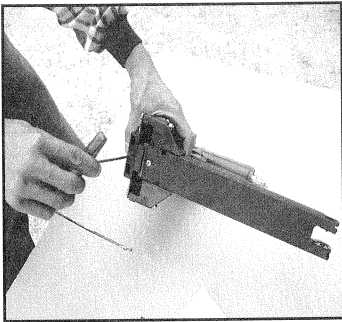

LOOSEN SET SCRCW (526) WITH 3 mm HEXAGON WRENCH KEY .

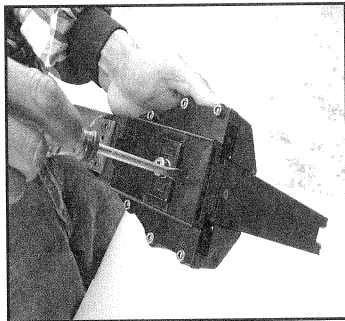

TURN ADJUSTING FOD (018) 180° WITH A SCREW DRIVER TO THE DESIRED ADJUSTMENT .

STAPLES LENGTHS	15MM	18MM
ROD POSITION	S — L	L — S

IF WANT TO SHOOT LONG LEG STAPLES. LET “L” ON ADJUSTING ROD (018) UP .

STAPLES LENGTHS	18MM	22MM
ROD POSITION	S — L	L — S

IF WANT TO SHOOT SHORT LEG STAPLES. LET “S” UP .

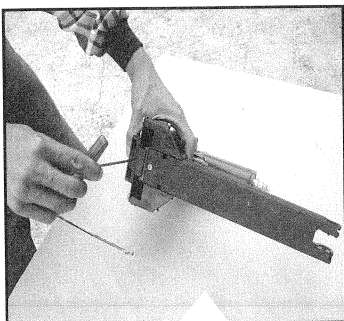

TIGHTEN SET SCREW (526)

CLINCH ADJUSTMENT

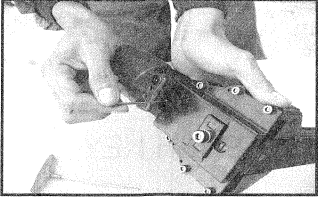

NOTE : DISCONNECT THE AIR SUPPLY

USE ROD (DIA 3 mm) OR 2.5 mm HEXAGON WRENCH KEY . TURN COLLAR (006) THROUGH WINDOW CLOCKWISE TO CHINCH .

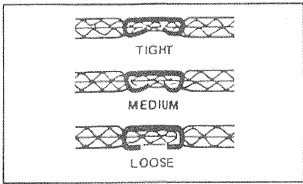

NOTE : REMOVE ADJUSTING TOOL AFTER ADJUSTMENT IS MADE .

DEPTH ADJUSTMENT

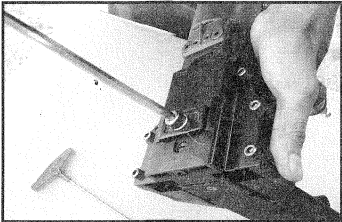

NOTE : DISCONNECT THE AIR SUPPLY

LOOSEN FRONT SCREW (527) WITH 6 mm HEXAGON WRENCH KEY .

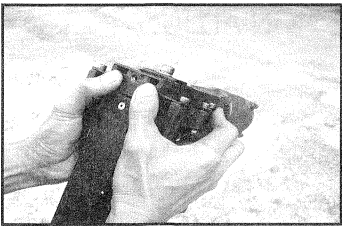

PUSH THE BODY (007) UP AND ADJUST TO DESIRED DEPTH .

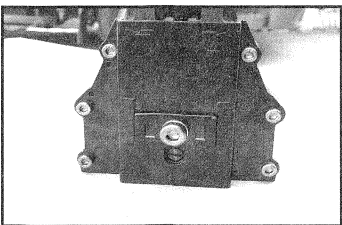

WHEN TOP EDGE OF ADJUSTMENT PLATE (019) IS AT IT'S HIGHEST SETTING (NO.4), THE TEETH (021,022) ARE AT THEIR SHALLOWEST PENETRATION . IF SET AT LOWEST SETTING

(NO,1) THE TEETH (021,022) ARE AT THEIR DEEPEST PENETRATION .

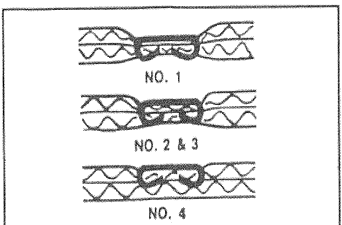

OPERATING THE TOOL

WARNING

PROTECT YOUR EYES AND EARS . WEAR SAFETY GLASSES WITH SIDE SHIELDS . WEAR HEARING PROTECTION . EMPLOYERS AND USERS ARE RESPONSIBLE FOR ENSURING THE USER OR ANYONE NEAR THE TOOL WEAR THIS SAFETY PROTCTION .

WARNING

TO PREVENT ACCIDENTAL INJURIES : NEVER , PLACE A HAND OR ANY OTHER PART OF BODY IN STAPLE CLINCHING AREA OT ADJUSTMENT WINDOW . NEVER POINT TOOL TOWARD ANYONE ELSE . NEVER ENGAGE IN HORSEPLAY . ALWAYS HANDLE THE TOOL WITH CARE . NEVER PULL TRIGGER UNLESS TOOL IS IN PLACE OF CARTON.

NOTE

CHECK AND REPLACE ANY DAMAGED OR WORN COMPONENTS ON THE TOOL MUST ALSO BE REPLACED IF THEY ARE NOT LEGIBLE .

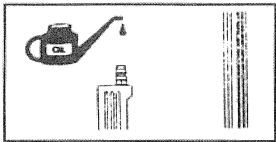

ADD A FEW DROPS OF UNOCAL R_x22 OR 3-IN-1 OIL INTO THE AIR INLET .

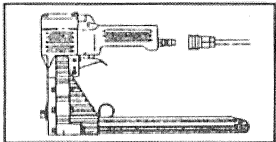

INSTALL A QUICK CONNECT FITTING TO THE TOOL .

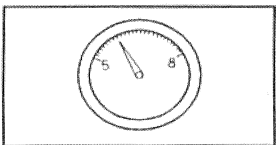

REAUULATE THE AIR PRESSURE TO IBTAIN 6 kg/cm² THE TOOL .

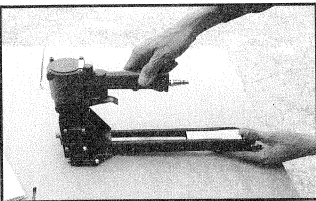

INSERT STAPLES INTO YOUR TOOL FOLLOWING THE INSTRUCTIONS OF LOADING THE TOOL .

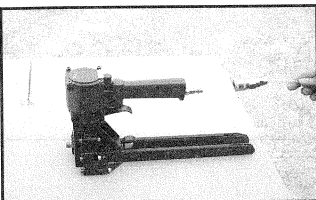

RECONNECT THE AIR HOSE TO THE TOOL .

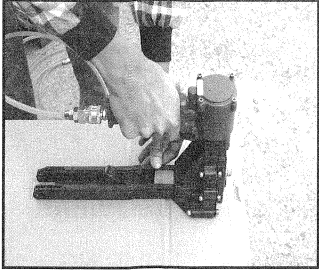

GRASP HANDLE WITH ONE HAND POSITION ON BOX IN LINE WITH THE DESIRED STAPLE LOCATION . THERE IS A SMALL PROJECTION EITHER SIDE OF THE MAGAZINE SEAT (038) AS AN AID IN LOCATING THE POSITION OF THE STAPLE . (011)

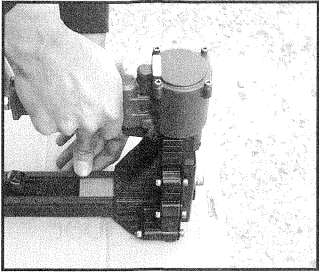

STRONGEST CLOSURE REQUIRES END STAPLES CLOSE TO END OF BOX .

CHECK STAPLE CLINCHING IN SAMPLES OF BOX BOARD BEING USED . ADJUSTMENTS FOR DEPTH OF PENETRATION & TIGHTNESS OF CLINCH ARE EASY & INSTANTANEOUS , FULL ADVANTAGE SHOULD BE TAKEN OF THEM .

CLEANING THE TOOL

DANGER

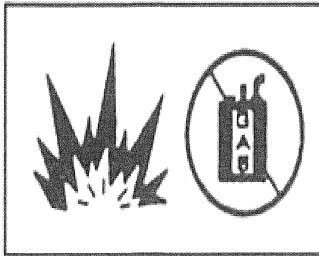

NEVER USE GASOLINE OR OTHER FLAMMABLE LIQUIDS TO CLEAN THE TOOL . VAPORS IN THE TOOL WILL IGNITE BY A SPARK AND CAUSE THE TOOL TO EXPLODE AND RESULT IN DEATH OR SERIOUS PERSONAL INJURY.

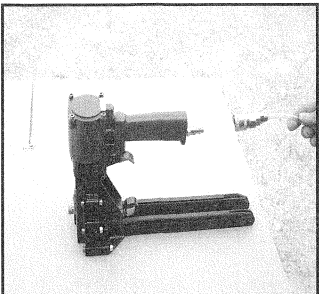

DISCONNECT THE AIR SUPPLY FROM THE TOOL.

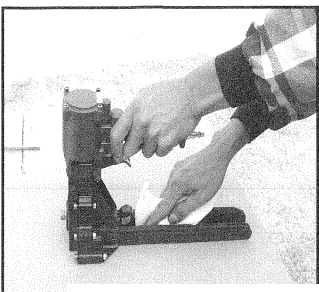

REMOVE TAR BUILDUP WITH KEROSENE #2 FUEL OIL OR DIESEL FUEL . DO NOT ALLOW SOLVENT TO GET INTO THE CYLINDER OR DAMAGE MAY OCCUR . DRY OFF THE TOOL COMPLETELY BEFORE USE .

CLEARING A JAM FROM THE TOOL

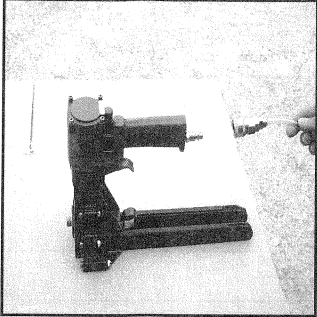

DISCONNECT THE AIR SUPPLY .

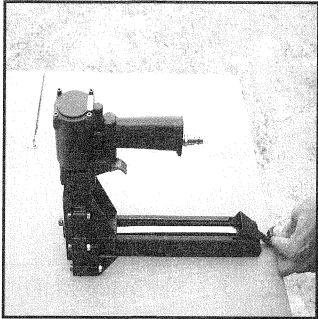

PULL PUSHER (036) BACK AND ROTATE TO LOCKED POSITION .

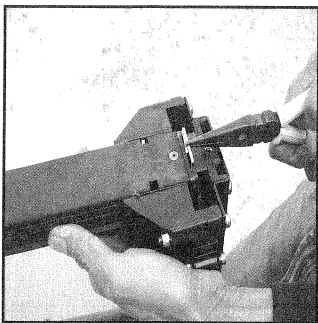

INSERT LONG NOSE PLIERS OR SCREW DRIVER TO CLEAR JAM .

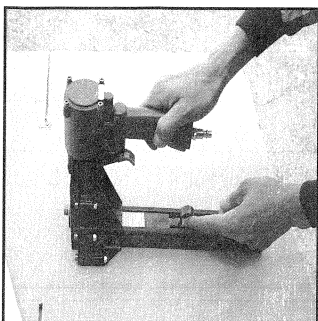

SLOWLY RELEASE PUSHER (036) BACK TO POSITION .

TROUBLESHOOTING

WARNING

STOP USING THE TOOL IMMEDIATELY IF ANY OF THE FOLLOWING PROBLEMS OCCUR .
SERIOUS PERSONAL INJURY COULD OCCUR . ANY REPAIRS OR REPLACEMENTS MUST BE
DONE BY A QUALIFIED PERSON OR AN AUTHORIZED SERVICE CENTER ONLY .

PROBLEM	CAUSE	REMEDY
AIR LEAKAGE FROM TRIGGER .	O-RING ON VALVE (016)OR ON TUBE (017) ARE DAMAGED .	O-RING MUST BE REPLACED
AIR LEAKAGE FROM EXHAUST PORT .	O-RINGSON VALVE (016)OR ON TUBE (017) ARE DAMAGED .	O-RING MUST BE REPLACED
	PISTON'S O-RING (507) IS DAMAGED .	O-RING MUST BE REPLACED
AIR LEAKAGE RROM CYLINDER (004) .	PISTON ROD PORT (007) O-RING (519) IS DAMAGED .	REPLACE THE O-RING .
SLOW AND SHORT TRAVEL CYCLING	CHECK FOR LOOSEND SCREW (517) AND WEAR OF PARTS (014,009)	POSITION ECCENTRIC PIN (013) AS SHOWN AND TIGHTEN SCREW (517) RECHECK , FOR MAXIMUM EFFICIENCY , SLIGHT ADJUSTMENT OF PIN AT THE POSITION SHOWN MUST BE MADE UPWARD DIRECTION IF SHORT TRAVEL OCCURS AND DOWNWARD DIRECTION IF SLOW CYCLING OCCURS .
EXCESSIVE JAMS :	SLOW AND SHORT TRAVEL CYCLING .	CHECK AS NOTED IN SLOW AND SHORT TRAVEL CYCLING SECTION .
	TEETH SCREWS LOOSE .	TIGHTEN SCREWS
	STAPLE SIZE IS WRONG .	USE THE PROPER SIZE STAPLE
	INSUFFICIENT LUBRICATION	CLEANING AND LUBRICATING SUITABLY .
UNEVEN CLINCH	WRONG STAPLE SIZE	CHECK FOR PROPER LEG LENGTH ADJUSTMENT & CLINCHER SIZE .
UNCLINCHED STAPLE	TEETH (021,022) LOOSE	TIGHTEN TEECH (021,022)
	TEETH (021,022) ARE BROKEN	REPLACE TEECH (021,022)
	SLOW AND SHORT TRAVEL CYCLING .	CHECK AS NOTED IN SLOW AND SHORT TRAVEL CYCLING SECTION .

TEETH REPLACEMENT

NOTE : DISCONNECT THE AIR SUPPLY

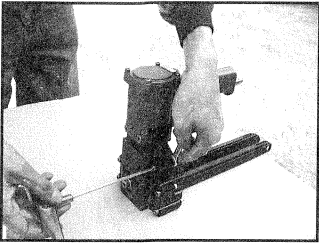

LOOSEN SCREWS (530 , 531) AND NUT (542) WITH 8 mm SPANNER AND 4 mm HEXAGON WRENCH KEY .

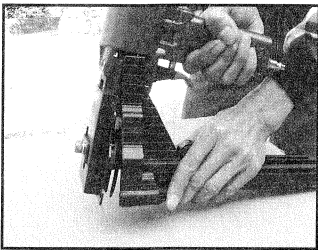

REMOVE THE MAGAZINE (030) ASSEMBLY .

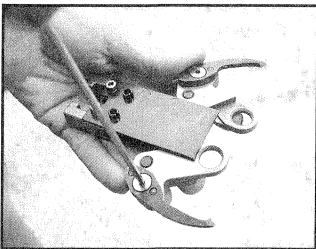

LOOSEN SCREWS (532) WITH 3 mm HEXAGON WREM KEY .
CHANGE TEETH ONE AT A TIME TO PREVENT REVERS
TEETH .

DRIVER REPLACEMENT

NOTE : DISCONNECT THE AIR SUPPLY

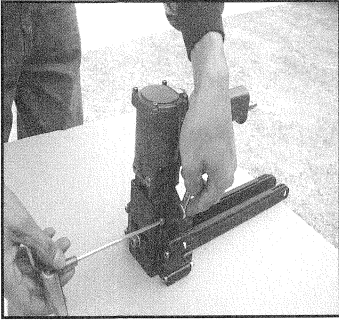

LOOSEN SCREWS(530,531)AND NUT(542)WITH 8 mm SPANNER AND 4 mm HEXAGON WRENCH KEY .

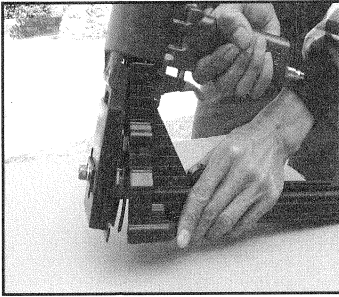

REMOVE THE MAGAZINE ASSEMBLY (030) .

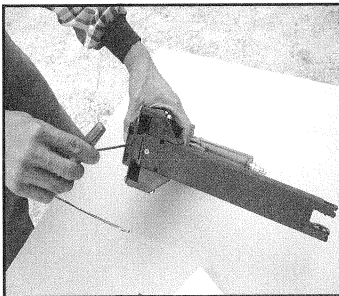

LOOSEN SET SCREW (526) WITH 3 mm HEXAGON WRENCH KEY TO UNLOCK ADJUSTING ROD (018) .

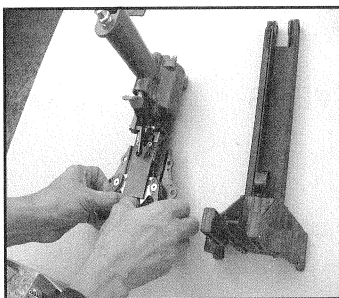

SLIDE LINKAGE MECHANISM AND ADJUSTING ROD (018) SIMULTANEOUSLY FROM COLLAR (006) .

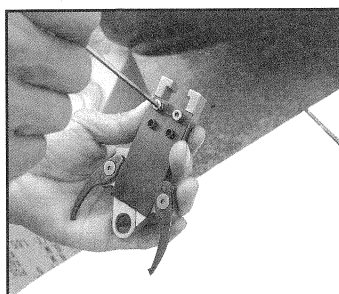

LOOSEN SCREWS (535) WITH 3 mm HEXAGON WRENCH KEY . TAKE OFF THE SPRING PIN (537) WITH HAMMER AND 6 mm STRAIGHT ROD .

PUSHER SPRING REPLACEMENT

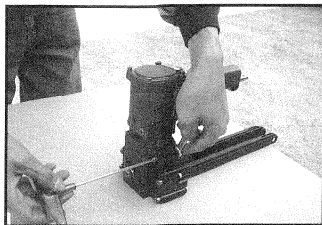

LOOSEN SCREWS (530,531) AND NUT (542) WITH 8 mm SPANNER AND 4 mm HEXAGON WRENCH KEY .

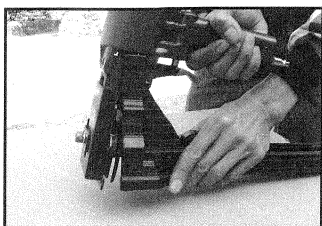

REMOVE THE MAGAZINE ASSEMBLY (030) .

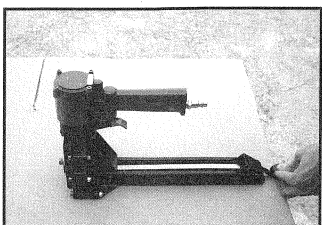

PULL PUSHER (036) BACK UNTIL IT STOPS ON ROD , THEN ROTATE PUSHER TO POSITION .



PUSH THE MAGAZINE SEAT (038) BACK AND TAKE OFF IT FROM MAGAZINE .

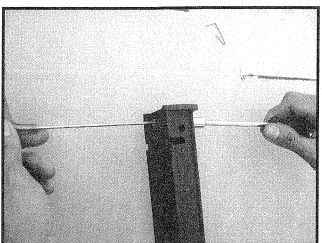

LOOSEN SCREW (540) AND NUT (541) WITH 2.5 mm HEXAGON WRENCH KEY AND 7 mm SOCKET WRINCH .

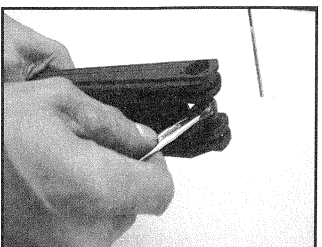

LOOSEN ROD (032) WITH 6 mm OFFSET WRENCH REMOVE PUSHER GUIDES (033) . REMOVE PUSHER (030)

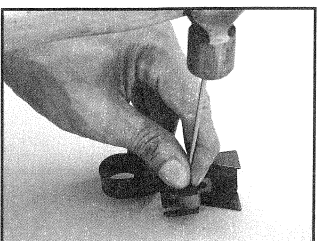

REMOVE SPRING PIN (545) WITH HAMMER AND 4 mm (DIA) STRAIGHT ROD .

VALVE'S AND TUBE'S O-RINGS REPLACEMENT

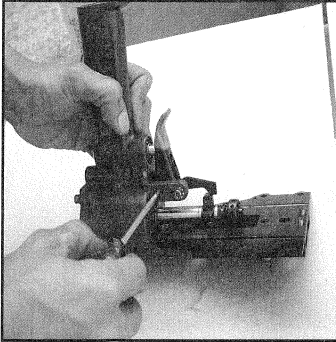

LOOSEN SCREWS (513) WITH FLAT SCREW DRIVER .

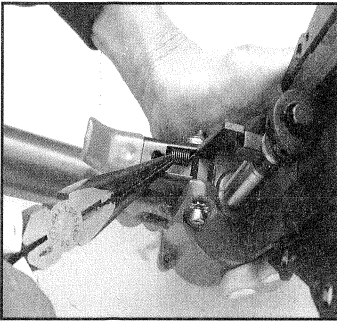

REMOVE SPRING (012) LONG NOSE PLIERS .

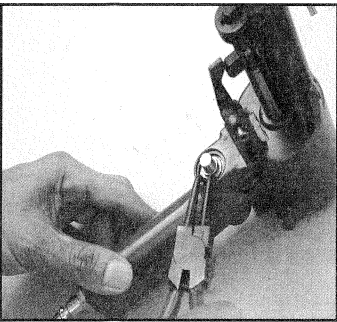

REMOVE C-RING (546) WITH C-RING PLIERS .

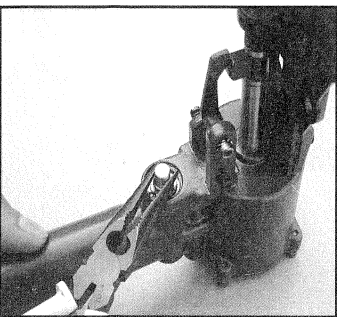

REMOVE VALVE (017) AND TUBE (016) WITH A LONG NOSE PLIERS .

PISTON REPLACEMENT

NOTE : DISCONNECT THE AIR SUPPLY

REMOVE SCREWS (530,531) AND NUT (542) WITH 8 mm SPANNER AND 4 mm HEXAGON WRENCH KEY .

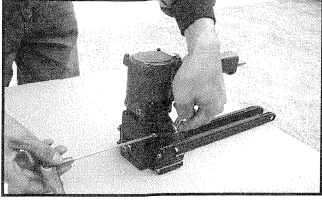

REMOVE THE MAGAZINE ASSEMBLY (030) .

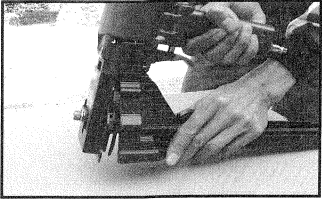

LOOSEN SET SCREW (526) WITH 3 mm HEXAGON WRENCH KEY TO UNLOCK ADJUSTING ROD (018) .

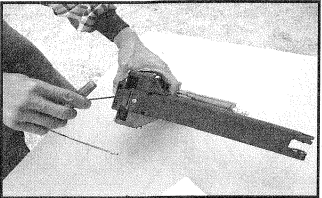

SLIDE LINKAGE MECHANISM AND ADJUSTING ROD (018) SIMULTANEOUSLY FROM COLLAR (006) .

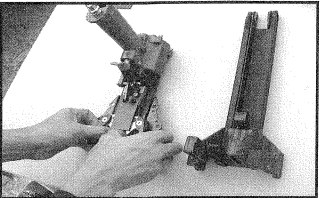

LOOSEN COLLAR (006) WITH 3 mm HEXAGON WRENCH KEY REMOVE SPRING (005) .

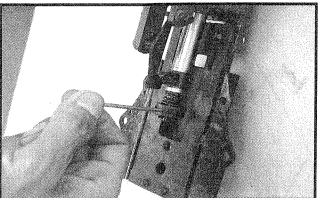

LOOSEN SCREW (510) WITH 3 mm HEXAGON WRENCH KEY REMOVE BLOCK (004) THROUGH WINDOW .

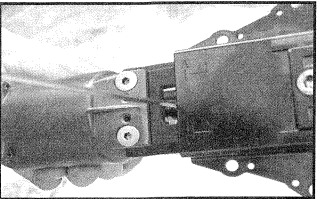

LOOSEN SCREWS (501) WITH 3 mm HEXAGON WRENCH KEY . REMOVE CAP (001) .

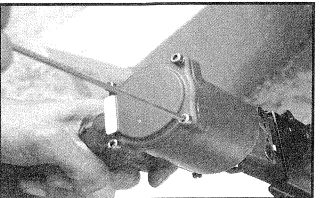

REMOVE PISTON ASSEMBLY . LOOSEN NUT (504) WITH 10 mm SPANNER . REMOVE PISTON (002) AND EXCHANGE A NEW ONE .

